



# Zubehör

Accessories

Accessoires

Yedekler

INHALTSVERZEICHNIS / INDEX	Seite / Page
<b>Spannfutter - Collet chuck</b> Mandrin á pines - Pens başlığı	10.01 - 10.02
<b>Schrumpfverlängerungen - Shrink fit extensions</b> Allonge - Silindirik ıstmalı takım tutucu	10.03
<b>Fräsdorne für Einschraubfräser - Milling cutter arbors</b> Axes coupeur fraise - Vidalı tip silindirik takım tutucu	10.04 - 10.05
<b>Reduzierungen für Einschraubfräser - Reducing for mill. cutter</b> Extension pour vis - Vidalı tip frezeler için ara adaptör	10.05 - 10.06
<b>Gewindeschneidfutter - Quick change tapping chuck</b> Appareil á tarauder - Kılavuz çekme başlığı	10.06
<b>Sägeblattaufnahme - Saw blade holder</b> Porte-lame de scie - Daire testere tutucu	10.07
<b>Reduziereinsätze - Reducing bushings</b> Réduction - Silindirik şaftlı redüksiyon	10.07
<b>Spannzangen - Collets</b> Pinces de serrage - Pensler	10.08 - 10.18
<b>Spannzangen mit Präzisionskraftspannfutter - Collet EKS</b> Pinces EKS - Bilyalı pens tutucu pensi	10.19
<b>Reduzierungen für Hydrodehn - Redcing arbor for hydraulic</b> Douille de réduction hydrauliques - Hidrolik takım tutucu pensi	10.20 - 10.21
<b>Spannzangensatz in Koffer - Collet set in box</b> set de pines dans valise - Pens takımı plastik kutuda	10.22 - 10.23
<b>Spannmutter - Clamping nuts</b> Écrou de serrage - Pens kapağı	10.24 - 10.26
<b>Dichtscheiben für Spannmuttern - Sealing for clamping Nuts</b> Joints écrou de serrage - Su sızdırmazlık ringi kapaklar için	10.27
<b>Reduzierbuchse für Bohrstangenhalter - Reduction bushes</b> Douille de réduction - Delik kateri redüksiyonu	10.28 - 10.30
<b>Anzugsbolzen - Pull studs</b> Tirettes - Çektirme civataları	10.31 - 10.33
<b>Einsätze mit Rutschkupplung - Tapping collets</b> Douille limiteur - Kılavuz tutucu	10.34 - 10.36
<b>Gewindebohrerhalter - Tap holder</b> Porte-taraud - Silindirik şaftlı kılavuz tutucu	10.37
<b>Spannschrauben - Clamping screw</b> Vis de serrage - Sıkma civatası	10.38 - 10.40



ZUBEHÖR  
ACCESSORIES



# Zubehör

Accessories

Accessoires

Yedekler

INHALTSVERZEICHNIS / INDEX	Seite / Page
<b>Anschlagschraube - Stop screw</b> Vis ajuster - Dayama civatası	10.41 - 10.43
<b>Paßfeder - Feather key</b> Ressort de passage - Kama	10.44
<b>Mitnehmersteine mit Schraube - Drive key</b> Entraineur - Vidalı kama	10.44
<b>Unterlegplatte - Shim</b> Plaque entretoise - Kater laması	10.44
<b>Fräseranzugsschrauben DIN6367 - Drawn in bolt DIN6367</b> Vis de serrage DIN6367 - Tarama başlık sıkma civatası DIN6367	10.45
<b>Mitnehmerringe DIN6366 - Clutch drive rings DIN6366</b> Bague de'entraînement DIN6366 - Tınaklı pul DIN6366	10.46
<b>Schraubenschlüssel - Wrenches</b> Clés - Anahtarlar	10.46 - 10.49
<b>Bohrfutter - Drill chuck</b> Mandrin de peçage á serrage - Süper supra mandren	10.49
<b>Kühlmittelübergabeeinheit - Delivery unit for coolant</b> Unité de transmission de liquide - Soğutma suyu ünitesi	10.50
<b>Kunststoff-Kugelspritzdüse - Ball sprayer nozzle</b> Buse d'injection spherique - Su verme misketi	10.50 - 10.51
<b>Kegelwischer - Taper wiper</b> Cônes de nettoyage - Konik temizleyici	10.51
<b>Montage blocks - Assembly blocks</b> Blocs de montage - Montaj aparatları	10.52 - 10.54
<b>NC-Bohrfutter mit MK shaft - NC drill chuck with MK shaft</b> Mandrin de peçage CNC avec cône morse - MK şaftı NC mandren malafası	10.54
<b>Bohrfutter Köpfe - Drill heads</b> Tete de peçage - Madren	10.55 - 10.57
<b>Tischwerkzeuggestell - Benchtop tool shelf</b> Support de table pour outils - Takım sehpa ve arabası	10.58 - 10.59



## Spannfutter mit Zylinderschaft



Collet chuck with cylindrical shank

Mandrin á pince á quene cylindrique

Silindirik şaftlı pens başlıkları

Bestell-Nr. Order Nr. Référence Sipariş Nr.	d	Spannbereich Capacity Capacité Kapasite	L	L1	D	Euro
120.0205.12.50.M	12	ER 8 Mini (1 - 5)	50	24	12	
120.0205.12.100.M	12	ER 8 Mini (1-5)	100	24	12	
120.0205.12.150.M	12	ER 8 Mini (1-5)	150	24	12	
120.0207.12.50.M	12	ER 11 Mini (1-7)	50	25	16	
120.0207.12.100.M	12	ER 11 Mini (1-7)	100	25	16	
120.0207.12.150.M	12	ER 11 Mini (1-7)	150	25	16	
120.0207.16.50.M	16	ER 11 Mini (1-7)	50	25	16	
120.0207.16.100.M	16	ER 11 Mini (1-7)	100	25	16	
120.0207.16.150.M	16	ER 11 Mini (1-7)	150	25	16	
120.0210.16.60.M	16	ER 16 Mini (1-10)	60	30	22	
120.0210.16.100.M	16	ER 16 Mini (1-10)	100	30	22	
120.0210.16.150.M	16	ER 16 Mini (1-10)	150	30	22	
120.0210.20.60.M	20	ER 16 Mini (1-10)	60	30	22	
120.0210.20.100.M	20	ER 16 Mini (1-10)	100	30	22	
120.0210.20.150.M	20	ER 16 Mini (1-10)	150	30	22	



### Zubehör / Accessories / Accessoires / Yedekler



Spannzangen System ER  
Collets System ER  
Pinces de serrage System ER  
Pens ER



Spannmutter Mini  
Nut Mini  
Écrou mini  
Mini kapak



Rollenschlüssel für Spannmutter  
Roller Bearing Wrenches  
Cles á rouleaux  
Bilyalı Kapak Sıkma Anahtar



Spannschlüssel für ER  
Wrench ER  
Clé de serrage ER  
Anahtar ER



11.01



## Spannfutter mit Zylinderschaft durchbohrt

Collet chuck with cylindrical shank bored through

Mandrin á princes á quene cylindrique percee

Silindirik şaftlı pens başlıkları

Bestell-Nr. Order Nr. Référence Sipariş Nr.	d	Spannbereich Capacity Capacité Kapasite	L	L1	D	Euro
120.0210.16.60	16	ER 16 (1-10)	60	30	28	
120.0210.16.100	16	ER 16 (1-10)	100	30	28	
120.0210.16.150	16	ER 16 (1-10)	150	30	28	
120.0210.20.60	20	ER 16 (1-10)	60	30	28	
120.0210.20.100	20	ER 16 (1-10)	100	30	28	
120.0210.20.150	20	ER 16 (1-10)	150	30	28	
120.0210.25.60	25	ER 16 (1-10)	60	35	28	
120.0210.25.100	25	ER 16 (1-10)	100	35	28	
120.0210.25.150	25	ER 16 (1-10)	150	35	28	
120.0216.20.60	20	ER 25 (2-16)	60	50	42	
120.0216.20.100	20	ER 25 (2-16)	100	50	42	
120.0216.20.150	20	ER 25 (2-16)	150	50	42	
120.0216.25.60	25	ER 25 (2-16)	60	50	42	
120.0216.25.100	25	ER 25 (2-16)	100	50	42	
120.0216.25.150	25	ER 25 (2-16)	150	50	42	
120.0216.32.60	32	ER 25 (2-16)	60	50	42	
120.0216.32.100	32	ER 25 (2-16)	100	50	42	
120.0216.32.150	32	ER 25 (2-16)	150	50	42	
120.0220.20.60	20	ER 32 (2-20)	60	53	50	
120.0220.20.100	20	ER 32 (2-20)	100	53	50	
120.0220.20.150	20	ER 32 (2-20)	150	53	50	
120.0220.25.60	25	ER 32 (2-20)	60	53	50	
120.0220.25.100	25	ER 32 (2-20)	100	53	50	
120.0220.25.150	25	ER 32 (2-20)	150	53	50	
120.0220.32.60	32	ER 32 (2-20)	60	53	50	
120.0220.32.100	32	ER 32 (2-20)	100	53	50	
120.0220.32.150	32	ER 32 (2-20)	150	53	50	
120.0220.40.100	40	ER 32 (2-20)	100	53	50	
120.0220.40.150	40	ER 32 (2-20)	150	53	50	
120.0226.32.70	32	ER 40 (2-26)	70	63	63	
120.0226.32.100	32	ER 40 (2-26)	100	63	63	
120.0226.32.150	32	ER 40 (2-26)	150	63	63	
120.0226.40.70	40	ER 40 (2-26)	70	63	63	
120.0226.40.100	40	ER 40 (2-26)	100	63	63	
120.0226.40.150	40	ER 40 (2-26)	150	63	63	

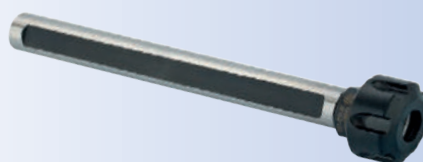

ER 16

### Zubehör / Accessories / Accessoires / Yedekler



Spannzangen System ER  
Collets System ER  
Pinces de serrage System ER  
Pens ER



Spannmutter ER  
Clamping nuts ER  
Écrou de serrage ER  
Pens kapağı ER



Spannschlüssel für ER  
Wrench ER  
Clé de serrage ER  
Anahtar ER



11.01

## Shrink fit extensions

### Allonge

### Silindirik ısıtılmalı takım tutucu

Bestell-Nr. Order Nr. Référence Sipariş Nr.	D	d1	d2	A	L1	L2	L3	M	Euro
120.25.12.03.150	12	3	8	150	-	-	12	-	
120.25.12.04.150	12	4	8	150	-	-	16	-	
120.25.16.03.150	16	3	10	150	-	-	12	-	
120.25.16.04.150	16	4	10	150	-	-	16	-	
120.25.16.05.150	16	5	10	150	-	-	20	-	
120.25.16.06.150	16	6	10	150	36	10	26	M5	
120.25.20.03.150	20	3	10	150	-	-	12	-	
120.25.20.04.150	20	4	10	150	-	-	16	M6	
120.25.20.05.150	20	5	10	150	-	-	20	M6	
120.25.20.06.150	20	6	10	150	36	10	26	M5	
120.25.20.08.150	20	8	12	150	36	10	26	M6	
120.25.20.10.150	20	10	14	150	42	10	32	M8	
120.25.20.12.150	20	12	16	150	47	10	37	M10	
120.25.25.08.150	25	8	20	150	36	10	26	M6	
120.25.25.10.150	25	10	20	150	42	10	32	M8	
120.25.25.12.150	25	12	20	150	47	10	37	M10	
120.25.25.14.150	25	14	20	150	47	10	37	M10	
120.25.25.16.150	25	16	22	150	50	10	40	M10	
120.25.32.10.150	32	10	24	150	42	10	32	M6	
120.25.32.12.150	32	12	24	150	47	10	37	M10	
120.25.32.14.150	32	14	27	150	47	10	37	M10	
120.25.32.16.150	32	16	27	150	50	10	40	M10	
120.25.32.18.150	32	18	27	150	50	10	40	M10	
120.25.32.20.150	32	20	27	150	52	10	42	M10	

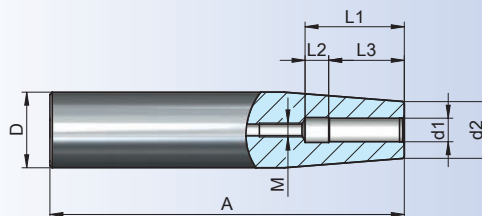



## Fräseraufnahmen für Einschraubfräser Zylinderschäfte

### Milling Cutter Arbors for Screw-on type Milling Cutters

### Axes Coupeur Fraisage Pour Vis-Sur Type Coupeurs de Fraisage

### Vidalı tip frezeler için silindirik şaftlı takım tutucular

Bestell-Nr. Order Nr. Référence Sipariş Nr.	D	M	d1	d2	d3	A	L	Euro
120.12.12.M05.020	12	M5	5,5	10	12	20	65	
120.12.20.M06.025	20	M6	6,5	10	18	25	75	
120.12.20.M06.050	20	M6	6,5	10	18	50	100	
120.12.20.M06.075	20	M6	6,5	10	18	75	125	
120.12.16.M08.040	16	M8	8,5	13	16	40	88	
120.12.20.M08.025	20	M8	8,5	13	18	25	75	
120.12.20.M08.050	20	M8	8,5	13	18	50	100	
120.12.20.M08.075	20	M8	8,5	13	18	75	125	
120.12.20.M10.025	20	M10	10,5	18	18	25	75	
120.12.20.M10.025.1	20	M10	10,5	18	20	25	80	
120.12.20.M10.050	20	M10	10,5	18	18	50	100	
120.12.20.M10.075	20	M10	10,5	18	18	75	125	
120.12.20.M10.097	20	M10	10,5	18	20	97	152	
120.12.25.M12.025	25	M12	12,5	21	25	25	81	
120.12.25.M12.040	25	M12	12,5	21	25	40	101	
120.12.25.M12.075	25	M12	12,5	21	25	75	131	
120.12.25.M12.109	25	M12	12,5	21	25	109	170	
120.12.25.M12.125	25	M12	12,5	21	25	125	181	
120.12.32.M12.105	32	M12	12,5	21	25	105	170	
120.12.32.M16.025	32	M16	17	29	32	25	85	
120.12.32.M16.040	32	M16	17	29	32	40	105	
120.12.32.M16.075	32	M16	17	29	32	75	135	
120.12.32.M16.125	32	M16	17	29	32	125	185	

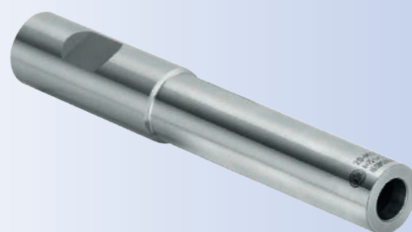
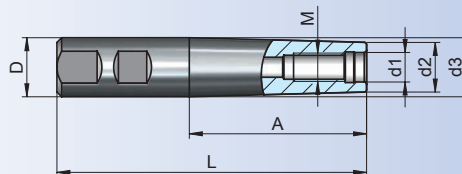

#### Empfohlene Anzugsmomente Recommended tightening torques Torques de serrage recommandés Önerilen sıkma torku

M6	10 Nm
M8	25 Nm
M10	40 Nm
M12	60 Nm
M16	80 Nm



## Fräseraufnahmen für Einschraubfräser Zylinderschäfte

Milling Cutter Arbors for Screw-on type Milling Cutters

Axes Coupeur Fraisage Pour Vis-Sur Type Coupeurs de Fraisage

Vidalı tip frezeler için silindirik şaftlı takım tutucular

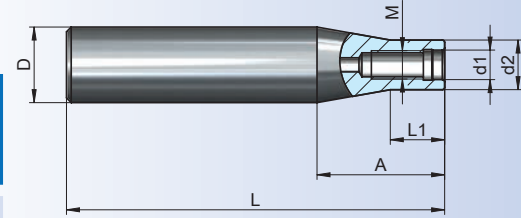

Bestell-Nr. Order Nr. Référence Sipariş Nr.	D	M	d1	d2	L1	A	L	Euro
123.12.20.M10.067	20	M10	10,5	18	67	68,7	160	
123.12.25.M12.077	25	M12	12,5	21	77	87,5	240	
123.12.32.M12.023	32	M12	12,5	21	23	54	160	
123.12.32.M12.059	32	M12	12,5	21	59,5	134	300	
123.12.32.M16.066	32	M16	17	29	66	68,7	160	
123.12.32.M16.146	32	M16	17	29	146	148,7	300	

Empfohlene Anzugsmomente Recommended tightening torques Torques de serrage recommandés Önerilen sıkma torku	
M6	10 Nm
M8	25 Nm
M10	40 Nm
M12	60 Nm
M16	80 Nm

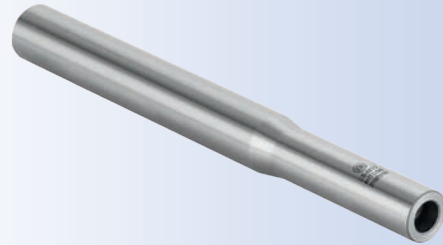

## Verlängerungen für Einschraubfräser

Extensions for milling cutter arbors

Extension pour - sur - type coupeurs de fraisage

Vidalı tip frezeler için ara adaptör

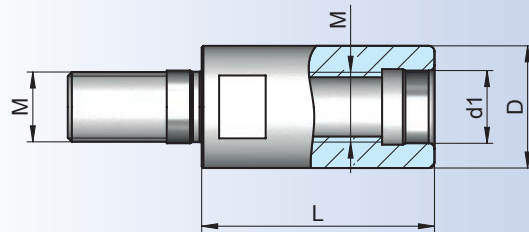

Bestell-Nr. Order Nr. Référence Sipariş Nr.	D	M	d1	L	Euro
124.12.13.M08.030	13	M8	8,5	30	
124.12.18.M10.035	18	M10	10,5	35	
124.12.21.M12.040	21	M12	12,5	40	
124.12.29.M16.040	29	M16	17	40	





## Reduzierungen für Einschraubfräser

Reducing for milling cutter arbors

Extension pour vis - sur - type coupeurs de fraisage

Vidalı tip frezeler için ara adaptör

Bestell-Nr. Order Nr. Référence Sipariş Nr.	D	M x M1	d1	d2	d3	L	Euro
126.12.13.M0608.030	13	M6-M8	5,5	10	8,5	30	
126.12.18.M0810.030	18	M8-M10	8,5	13	10,5	30	
126.12.21.M1012.035	21	M10-M12	10,5	18	12,5	35	
126.12.29.M1016.060	29	M10-M16	10,5	18	17	60	
126.12.29.M1216.060	29	M12-M16	12,5	21	17	60	

Empfohlene Anzugsmomente Recommended tightening torques Torques de serrage recommandés Önerilen sıkma torku	
M6	10 Nm
M8	25 Nm
M10	40 Nm
M12	60 Nm
M16	80 Nm

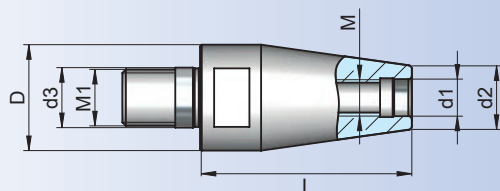

## Gewindeschneid - Schnellwechselfutter mit Längenausgleich auf Druck und Zug

Quick-change tapping chucks with length compensation

Appareil à tarauder avec compensation longitudinale

Kılavuz çekme başlığı giriş ve çıkış kompanzeli

Bestell-Nr. Order Nr. Référence Sipariş Nr.	D1	Spannbereich Capacity Capacité Kapasite	d	A	D	L	C	T	Euro
120.16.12.20.41	20	M2-M14	19	41	36,5	50	7	7	
120.16.12.25.41	25	M2-M14	19	41	36,5	50	7	7	
120.16.12.32.41	32	M2-M14	19	41	36,5	61	7	7	
120.16.12.40.41	40	M2-M14	19	41	36,5	68	7	7	
120.16.20.20.110	20	M5-M24	31	110	53,5	50	12	12	
120.16.20.25.75	25	M5-M24	31	75	53,5	50	12	12	
120.16.20.32.75	32	M5-M24	31	75	53,5	61	12	12	
120.16.20.40.75	40	M5-M24	31	75	53,5	68	12	12	
120.16.36.40.115	40	M14-M36	48	115	78	68	17,5	17,5	

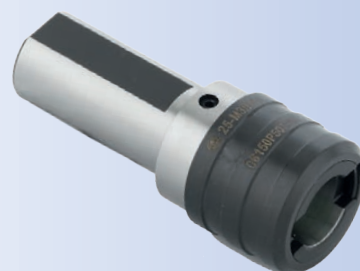
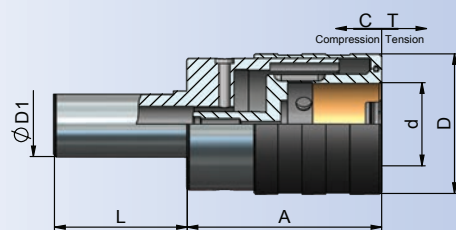

## Zubehör / Accessories / Accessoires / Yedekler

10.34 - 10.36	Schnellwechseleinsätze Tapping collets Dovilles de taraudage Kılavuz tutucu
---------------	--





## Sägeblattaufnahme

### Saw blade holder

### Porte - lame de scie

### Daire testere tutucu

Bestell-Nr. Order Nr. Référence Sipariş Nr.	Sägeblatt Ø	D	d1	d	A	L	Euro
121.20.05.040	20	20	10	5	40	90	
121.20.08.050	25/32	20	13	8	50	100	
121.20.10.060	40	20	19,5	10	60	110	
121.25.13.080	50	25	24,5	13	80	136	
121.25.16.080	63	25	24,5	16	80	136	

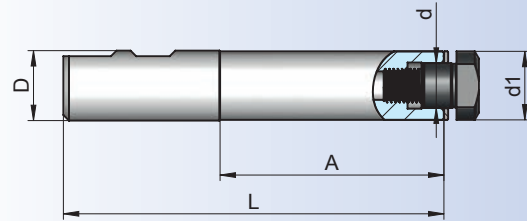

Verwendung : Zur Aufnahme von Sägeblättern in Fräseraufnahmen oder Spannfutter  
Application : For saw blade holders in end mill holder and collet chuck  
Emploi : Pour la réception de lames de scie dans des porte-fraises ou des porte-pinces  
Kullanma Yeri : Veldon tutuculara ve pens başlığına bağlamak için daire testere malafası

## Reduziereinsätze DIN 1835 B für Zylinderschäfte DIN 1835 E

### Reducing bushings DIN 1835 B for cylindrical shanks DIN 1835E

### Réduction DIN 1835 B pour queue cylindriques DIN 1835 E

### Redüksiyon DIN 1835 B Silindirik şaftlı DIN 1835 E

Bestell-Nr. Order Nr. Référence Sipariş Nr.	d	d1	D	L	Euro
122.20.06.030	20	6	25	30	
122.20.08.030	20	8	28	30	
122.20.10.030	20	10	35	30	
122.20.12.035	20	12	42	35	

122.32.06.030	32	6	25	30	
122.32.08.030	32	8	28	30	
122.32.10.030	32	10	35	30	
122.32.12.035	32	12	42	35	
122.32.14.035	32	14	44	35	
122.32.16.038	32	16	48	38	
122.32.18.038	32	18	50	38	
122.32.20.040	32	20	52	40	

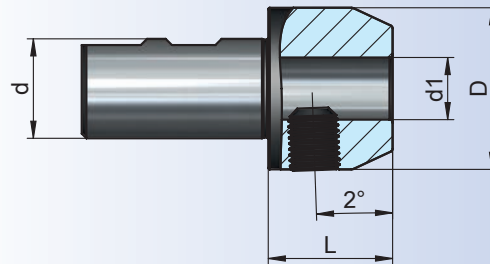

## Zubehör / Accessories / Accessoires / Yedekler



Spannschrauben  
Clamping screw  
Vis de serrage  
Sıkma civatası

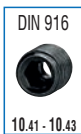

Einstellschraube  
Adjusting screw  
Vis de réglage  
Dayama civatası



## Collets DIN 6388 B

## Pincas de serrage DIN 6388, forme B

## Pensler DIN 6388 B Formu

Bestell-Nr. Order Nr. Référence Sipariş Nr.	d	D	L	Euro
415 E-02	2	25,5	40	
415 E-03	3	25,5	40	
415 E-04	4	25,5	40	
415 E-05	5	25,5	40	
415 E-06	6	25,5	40	
415 E-07	7	25,5	40	
415 E-08	8	25,5	40	
415 E-09	9	25,5	40	
415 E-10	10	25,5	40	
415 E-11	11	25,5	40	
415 E-12	12	25,5	40	
415 E-13	13	25,5	40	
415 E-14	14	25,5	40	
415 E-15	15	25,5	40	
415 E-16	16	25,5	40	

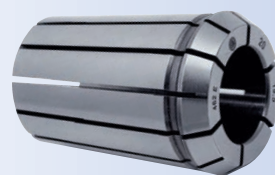
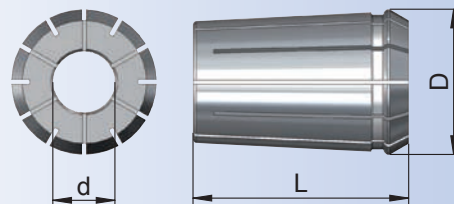

Spanntoleranz : - 0,5 mm  
Clamping capacity : - 0,5 mm  
Capacité de serrage : - 0,5 mm  
Sıkma kapasitesi : - 0,5 mm

Rundlaufgenauigkeit : 6µm  
Concentricity : 6µm  
Concentricité : 6µm  
Konsantriklik : 6µm

Komplettsatz : Seite 10.22  
Complete set : Page 10.22  
Kit complet : Voir page 10.22  
Komple set : Sayfa 10.22



## Collets DIN 6388 B

## Pinces de serrage DIN 6388, forme B

## Pensler DIN 6388 B Formu

Bestell-Nr. Order Nr. Référence Sipariş Nr.	d	D	L	Euro
462 E-02	2	35,05	52	
462 E-03	3	35,05	52	
462 E-04	4	35,05	52	
462 E-05	5	35,05	52	
462 E-06	6	35,05	52	
462 E-07	7	35,05	52	
462 E-08	8	35,05	52	
462 E-09	9	35,05	52	
462 E-10	10	35,05	52	
462 E-11	11	35,05	52	
462 E-12	12	35,05	52	
462 E-13	13	35,05	52	
462 E-14	14	35,05	52	
462 E-15	15	35,05	52	
462 E-16	16	35,05	52	
462 E-17	17	35,05	52	
462 E-18	18	35,05	52	
462 E-19	19	35,05	52	
462 E-20	20	35,05	52	
462 E-21	21	35,05	52	
462 E-22	22	35,05	52	
462 E-23	23	35,05	52	
462 E-24	24	35,05	52	
462 E-25	25	35,05	52	

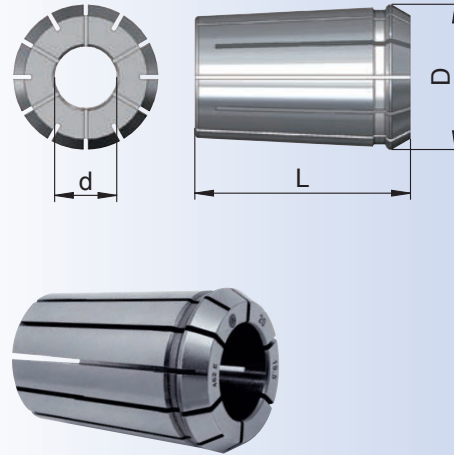

Spanntoleranz : - 0,5 mm  
Clamping capacity : - 0,5 mm  
Capacité de serrage : - 0,5 mm  
Sıkma kapasitesi : - 0,5 mm

Rundlaufgenauigkeit : 6µm  
Concentricity : 6µm  
Concentricité : 6µm  
Konsantriklik : 6µm

Komplettsatz : Seite 10.22  
Complete set : Page 10.22  
Kit complet : Voir page 10.22  
Komple set : Sayfa 10.22

**Collets DIN 6388 B**
**Pinces de serrage DIN 6388, forme B**
**Pensler DIN 6388 B Formu**

Bestell-Nr. Order Nr. Référence Sipariş Nr.	d	D	L	Euro
467 E-04	4	43,7	60	
467 E-05	5	43,7	60	
467 E-06	6	43,7	60	
467 E-07	7	43,7	60	
467 E-08	8	43,7	60	
467 E-09	9	43,7	60	
467 E-10	10	43,7	60	
467 E-11	11	43,7	60	
467 E-12	12	43,7	60	
467 E-13	13	43,7	60	
467 E-14	14	43,7	60	
467 E-15	15	43,7	60	
467 E-16	16	43,7	60	
467 E-17	17	43,7	60	
467 E-18	18	43,7	60	
467 E-19	19	43,7	60	
467 E-20	20	43,7	60	
467 E-21	21	43,7	60	
467 E-22	22	43,7	60	
467 E-23	23	43,7	60	
467 E-24	24	43,7	60	
467 E-25	25	43,7	60	
467 E-26	26	43,7	60	
467 E-27	27	43,7	60	
467 E-28	28	43,7	60	
467 E-29	29	43,7	60	
467 E-30	30	43,7	60	
467 E-31	31	43,7	60	
467 E-32	32	43,7	60	

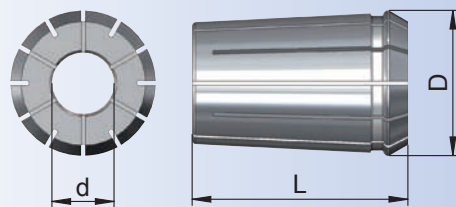

Spanntoleranz : - 0,5 mm  
Clamping capacity : - 0,5 mm  
Capacité de serrage : - 0,5 mm  
Sıkma kapasitesi : - 0,5 mm

Rundlaufgenauigkeit : 10µm  
Concentricity : 10µm  
Concentricité : 10µm  
Konsantriklik : 10µm

Komplettsatz : Seite 10.22  
Complete set : Page 10.22  
Kit complet : Voir page 10.22  
Komple set : Sayfa 10.22



## Collets System ER DIN 6499 B

## Pincas de serrage System ER DIN 6499, Forme B

## Pensler ER DIN 6499 B Formu

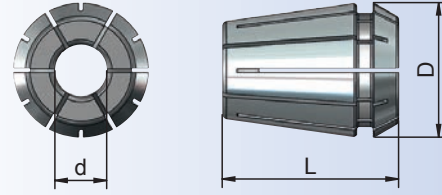

Bestell-Nr. Order Nr. Référence Sipariş Nr.	d	D	L	Euro
4004 E-01	1	8,5	13,6	
4004 E-1.5	1,5	8,5	13,6	
4004 E-02	2	8,5	13,6	
4004 E-02.5	2,5	8,5	13,6	
4004 E-03	3	8,5	13,6	
4004 E-03.5	3,5	8,5	13,6	
4004 E-04	4	8,5	13,6	
4004 E-04.5	4,5	8,5	13,6	
4004 E-05	5	8,5	13,6	

Spanntoleranz : - 0,5 mm  
Clamping capacity : - 0,5 mm  
Capacité de serrage : - 0,5 mm  
Sıkma kapasitesi : - 0,5 mm

Rundlaufgenauigkeit : 10µm  
Concentricity : 10µm  
Concentricité : 10µm  
Konsantriklik : 10µm

Komplettsatz : Seite 10.22  
Complete set : Page 10.22  
Kit complet : Voir page 10.22  
Komple set : Sayfa 10.22

## Spannzangen System ER DIN 6499 / ISO 15488-B

## ER 11 - B

## Collets System ER DIN 6499 B

## Pincas de serrage System ER DIN 6499, Forme B

## Pensler DIN 6499 B Formu

Bestell-Nr. Order Nr. Référence Sipariş Nr.	d	D	L	Euro
4008 E-01	1	11,5	18	
4008 E-1.5	1,5	11,5	18	
4008 E-02	2	11,5	18	
4008 E-02.5	2,5	11,5	18	
4008 E-03	3	11,5	18	
4008 E-03.5	3,5	11,5	18	
4008 E-04	4	11,5	18	
4008 E-04.5	4,5	11,5	18	
4008 E-05	5	11,5	18	
4008 E-05.5	5,5	11,5	18	
4008 E-06	6	11,5	18	
4008 E-06.5	6,5	11,5	18	
4008 E-07	7	11,5	18	

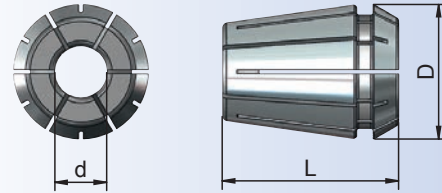

Spanntoleranz : - 0,5 mm  
Clamping capacity : - 0,5 mm  
Capacité de serrage : - 0,5 mm  
Sıkma kapasitesi : - 0,5 mm

Rundlaufgenauigkeit : 5µm  
Concentricity : 5µm  
Concentricité : 5µm  
Konsantriklik : 5µm

Komplettsatz : Seite 10.22  
Complete set : Page 10.22  
Kit complet : Voir page 10.22  
Komple set : Sayfa 10.22

**Collets System ER DIN 6499 B****Pinces de serrage System ER DIN 6499, Forme B****Pensler ER DIN 6499 B Formu**

Bestell-Nr. Order Nr. Référence Sipariş Nr.	d	D	L	Euro
426 E-01	1	17	27,5	
426 E-02	2	17	27,5	
426 E-03	3	17	27,5	
426 E-04	4	17	27,5	
426 E-05	5	17	27,5	
426 E-06	6	17	27,5	
426 E-07	7	17	27,5	
426 E-08	8	17	27,5	
426 E-09	9	17	27,5	
426 E-10	10	17	27,5	

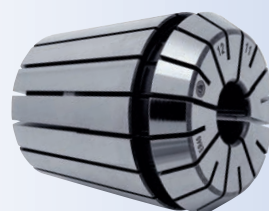
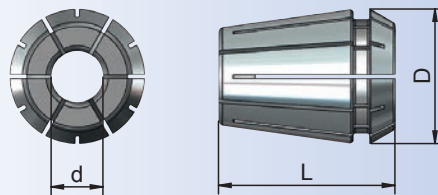

Spanntoleranz : Ø1-Ø2 (-0,5 mm) / Ø3-Ø10 (-1 mm)  
Clamping capacity : Ø1-Ø2 (-0,5 mm) / Ø3-Ø10 (-1 mm)  
Capacité de serrage : Ø1-Ø2 (-0,5 mm) / Ø3-Ø10 (-1 mm)  
Sıkma kapasitesi : Ø1-Ø2 (-0,5 mm) / Ø3-Ø10 (-1 mm)

Rundlaufgenauigkeit : 5µm  
Concentricity : 5µm  
Concentricité : 5µm  
Konsantriklik : 5µm

Komplettsatz : Seite 10.22  
Complete set : Page 10.22  
Kit complet : Voir page 10.22  
Komple set : Sayfa 10.22



## Collets System ER DIN 6499 B

## Pincas de serrage System ER DIN 6499, Forme B

## Pensler ER DIN 6499 B Formu

Bestell-Nr. Order Nr. Référence Sipariş Nr.	d	D	L	Euro
428 E-02	2	21	31,5	
428 E-03	3	21	31,5	
428 E-04	4	21	31,5	
428 E-05	5	21	31,5	
428 E-06	6	21	31,5	
428 E-07	7	21	31,5	
428 E-08	8	21	31,5	
428 E-09	9	21	31,5	
428 E-10	10	21	31,5	
428 E-11	11	21	31,5	
428 E-12	12	21	31,5	
428 E-13	13	21	31,5	

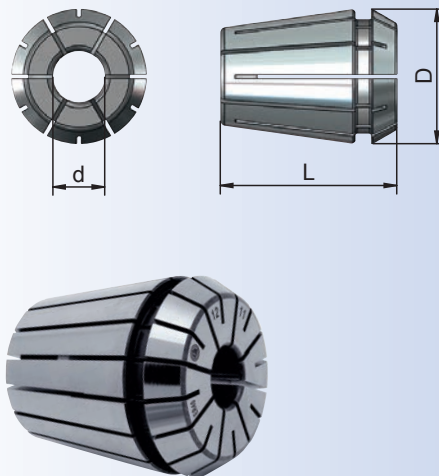

Spanntoleranz : Ø1-Ø2 (-0,5 mm) / Ø3-Ø13 (-1 mm)

Clamping capacity : Ø1-Ø2 (-0,5 mm) / Ø3-Ø13 (-1 mm)

Capacité de serrage : Ø1-Ø2 (-0,5 mm) / Ø3-Ø13 (-1 mm)

Sıkma kapasitesi : Ø1-Ø2 (-0,5 mm) / Ø3-Ø13 (-1 mm)

Rundlaufgenauigkeit : 5µm

Concentricity : 5µm

Concentricité : 5µm

Konsantriklik : 5µm

Komplettsatz : Seite 10.22

Complete set : Page 10.22

Kit complet : Voir page 10.22

Komple set : Sayfa 10.22



## Collets System ER DIN 6499 B

## Pinces de serrage System ER DIN 6499, Forme B

## Pensler ER DIN 6499 B Formu

Bestell-Nr. Order Nr. Référence Sipariş Nr.	d	D	L	Euro
430 E-02	2	26	34	
430 E-03	3	26	34	
430 E-04	4	26	34	
430 E-05	5	26	34	
430 E-06	6	26	34	
430 E-07	7	26	34	
430 E-08	8	26	34	
430 E-09	9	26	34	
430 E-10	10	26	34	
430 E-11	11	26	34	
430 E-12	12	26	34	
430 E-13	13	26	34	
430 E-14	14	26	34	
430 E-15	15	26	34	
430 E-16	16	26	34	

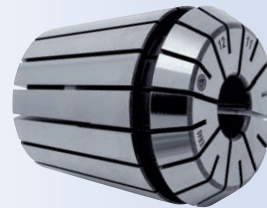
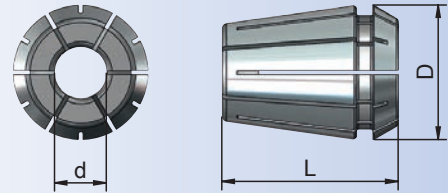

Spanntoleranz : Ø1-Ø2 (-0,5 mm) / Ø3-Ø16 (-1 mm)  
Clamping capacity : Ø1-Ø2 (-0,5 mm) / Ø3-Ø16 (-1 mm)  
Capacité de serrage : Ø1-Ø2 (-0,5 mm) / Ø3-Ø16 (-1 mm)  
Sıkma kapasitesi : Ø1-Ø2 (-0,5 mm) / Ø3-Ø16 (-1 mm)

Rundlaufgenauigkeit : 5µm  
Concentricity : 5µm  
Concentricité : 5µm  
Konsantriklik : 5µm

Komplettsatz : Seite 10.22  
Complete set : Page 10.22  
Kit complet : Voir page 10.22  
Komple set : Sayfa 10.22





## Collets System ER DIN 6499 B

## Pinces de serrage System ER DIN 6499, Forme B

## Pensler ER DIN 6499 B Formu

Bestell-Nr. Order Nr. Référence Sipariş Nr.	d	D	L	Euro
470 E-02	2	33	40	
470 E-03	3	33	40	
470 E-04	4	33	40	
470 E-05	5	33	40	
470 E-06	6	33	40	
470 E-07	7	33	40	
470 E-08	8	33	40	
470 E-09	9	33	40	
470 E-10	10	33	40	
470 E-11	11	33	40	
470 E-12	12	33	40	
470 E-13	13	33	40	
470 E-14	14	33	40	
470 E-15	15	33	40	
470 E-16	16	33	40	
470 E-17	17	33	40	
470 E-18	18	33	40	
470 E-19	19	33	40	
470 E-20	20	33	40	

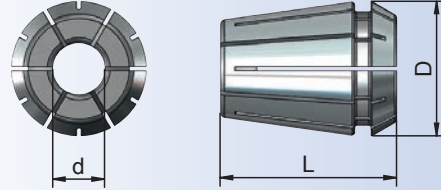

Spanntoleranz : -1 mm  
Clamping capacity : -1 mm  
Capacité de serrage : -1 mm  
Sıkma kapasitesi : -1 mm

Rundlaufgenauigkeit : 5µm  
Concentricity : 5µm  
Concentricité : 5µm  
Konsantriklik : 5µm

Komplettsatz : Seite 10.22  
Complete set : Page 10.22  
Kit complet : Voir page 10.22  
Komple set : Sayfa 10.22



## Collets System ER DIN 6499 B

## Pincés de serrage System ER DIN 6499, Forme B

## Pensler ER DIN 6499 B Formu

Bestell-Nr. Order Nr. Référence Sipariş Nr.	d	D	L	Euro
472 E-03	3	41	46	
472 E-04	4	41	46	
472 E-05	5	41	46	
472 E-06	6	41	46	
472 E-07	7	41	46	
472 E-08	8	41	46	
472 E-09	9	41	46	
472 E-10	10	41	46	
472 E-11	11	41	46	
472 E-12	12	41	46	
472 E-13	13	41	46	
472 E-14	14	41	46	
472 E-15	15	41	46	
472 E-16	16	41	46	
472 E-17	17	41	46	
472 E-18	18	41	46	
472 E-19	19	41	46	
472 E-20	20	41	46	
472 E-21	21	41	46	
472 E-22	22	41	46	
472 E-23	23	41	46	
472 E-24	24	41	46	
472 E-25	25	41	46	
472 E-26	26	41	46	

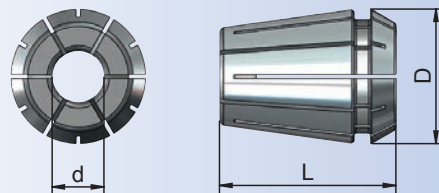

Spanntoleranz	: -1 mm	Rundlaufgenauigkeit	: 5 $\mu$ m
Clamping capacity	: -1 mm	Concentricity	: 5 $\mu$ m
Capacité de serrage	: -1 mm	Concentricité	: 5 $\mu$ m
Sıkma kapasitesi	: -1 mm	Konsantriklik	: 5 $\mu$ m

Komplettsatz	: Seite 10.22
Complete set	: Page 10.22
Kit complet	: Voir page 10.22
Komple set	: Sayfa 10.22

## Spannzangen System ER DIN 6499 A mit Vierkantaufnahme ohne Längenausgleich ER-GBD



Collet system ER DIN 6499 A with square locking drive without length-adjustment

Pinces System ER DIN 6499 avec carré d'entraînement, Forme A

Kılavuz pensi içten soğutmalı sistemler için keçeli tip, ER DIN 6499 A Formu

Bestell-Nr. Order Nr. Référence Sipariş Nr.	Spannbereich Capacity Capacité Kapasite	d	D	Vkt	L	Euro
ERGBD.10.3527	ER16	3,5	16,5	2,7	27,5	
ERGBD.10.0432	ER16	4	16,5	3,2	27,5	
ERGBD.10.4535	ER16	4,5	16,5	3,5	27,5	
ERGBD.10.0605	ER16	6	16,5	5	27,5	
ERGBD.10.0756	ER16	7	16,5	5,6	27,5	
ERGBD.10.0863	ER16	8	16,5	6,3	27,5	
<b>new</b> ERGBD.10.0871	ER16	9	16,5	7,1	27,5	

ERGBD.13.3527	ER20	3,5	20,7	2,7	31,5	
ERGBD.13.0432	ER20	4	20,7	3,2	31,5	
ERGBD.13.4535	ER20	4,5	20,7	3,5	31,5	
ERGBD.13.0605	ER20	6	20,7	5	31,5	
ERGBD.13.0756	ER20	7	20,7	5,6	31,5	
ERGBD.13.0863	ER20	8	20,7	6,3	31,5	
ERGBD.13.1008	ER20	10	20,7	8	31,5	
ERGBD.13.1109	ER20	11	20,7	9	31,5	
ERGBD.13.1209	ER20	12	20,7	9	31,5	

ERGBD.16.3527	ER25	3,5	25,7	2,7	34	
ERGBD.16.0432	ER25	4	25,7	3,2	34	
ERGBD.16.4535	ER25	4,5	25,7	3,5	34	
ERGBD.16.0605	ER25	6	25,7	5	34	
ERGBD.16.0756	ER25	7	25,7	5,6	34	
ERGBD.16.0863	ER25	8	25,7	6,3	34	
ERGBD.16.0971	ER25	9	25,7	7,1	34	
ERGBD.16.1008	ER25	10	25,7	8	34	
ERGBD.16.1109	ER25	11	25,7	9	34	
ERGBD.16.1209	ER25	12	25,7	9	34	
ERGBD.16.14112	ER25	14	25,7	11,2	34	
ERGBD.16.16125	ER25	16	25,7	12,5	34	

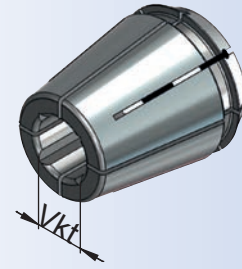
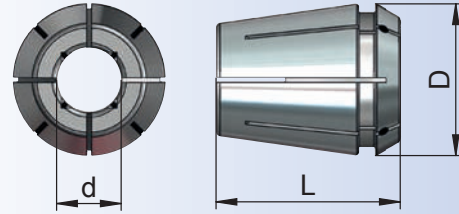

Spanntoleranz : h8  
Clamping capacity : h8  
Capacité de serrage : h8  
Sıkma kapasitesi : h8

Rundlaufgenauigkeit : 10 $\mu$ m  
Concentricity : 10 $\mu$ m  
Concentricité : 10 $\mu$ m  
Konsantriklik : 10 $\mu$ m



Collet system ER DIN 6499 A with square locking drive without length-adjustment

Pinces System ER DIN 6499 avec carré d'entraînement, Forme A

Kılavuz pensi içten soğutmalı sistemler için keçeli tip, ER DIN 6499 A Formu

Bestell-Nr. Order Nr. Référence Sipariş Nr.	Spannbereich Capacity Capacité Kapasite	d	D	Vkt	L	Euro
ERGBD.20.0432	ER32	4	32,7	3,2	40	
ERGBD.20.4535	ER32	4,5	32,7	3,5	40	
ERGBD.20.0605	ER32	6	32,7	5	40	
ERGBD.20.0756	ER32	7	32,7	5,6	40	
ERGBD.20.0863	ER32	8	32,7	6,3	40	
ERGBD.20.0971	ER32	9	32,7	7,1	40	
ERGBD.20.1008	ER32	10	32,7	8	40	
ERGBD.20.1109	ER32	11	32,7	9	40	
ERGBD.20.1209	ER32	12	32,7	9	40	
ERGBD.20.14112	ER32	14	32,7	11,2	40	
ERGBD.20.16125	ER32	16	32,7	12,5	40	
ERGBD.20.18145	ER32	18	32,7	14,5	40	
ERGBD.20.2016	ER32	20	32,7	16	40	
ERGBD.26.0605	ER40	6	40,7	5	46	
ERGBD.26.0756	ER40	7	40,7	5,6	46	
ERGBD.26.0863	ER40	8	40,7	6,3	46	
ERGBD.26.0971	ER40	9	40,7	7,1	46	
ERGBD.26.1008	ER40	10	40,7	8	46	
ERGBD.26.1109	ER40	11	40,7	9	46	
ERGBD.26.1209	ER40	12	40,7	9	46	
ERGBD.26.14112	ER40	14	40,7	11,2	46	
ERGBD.26.16125	ER40	16	40,7	12,5	46	
ERGBD.26.18145	ER40	18	40,7	14,5	46	
ERGBD.26.2016	ER40	20	40,7	16	46	
ERGBD.26.2218	ER40	22	40,7	18	46	
ERGBD.26.2520	ER40	25	40,7	20	46	

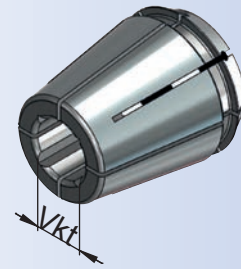
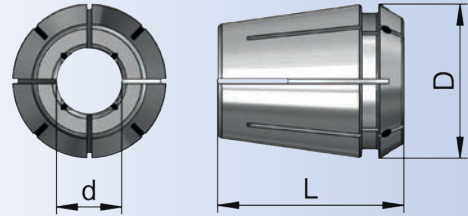

Spanntoleranz : h8  
Clamping capacity : h8  
Capacité de serrage : h8  
Sıkma kapasitesi : h8

Rundlaufgenauigkeit : 10µm  
Concentricity : 10µm  
Concentricité : 10µm  
Konsantriklik : 10µm

## Spannzangen für Präzisionskraftspannfutter



Collet for precision milling chuck

Pinces pour mandrin de fraisage de précision

Bilyalı takım tutucu için pensler

Bestell-Nr. Order Nr. Référence Sipariş Nr.	d	D	L	Euro
EKS 20-06	6	20	53	
EKS 20-08	8	20	53	
EKS 20-10	10	20	53	
EKS 20-12	12	20	53	
EKS 20-16	16	20	53	

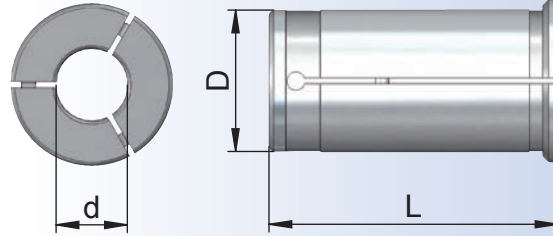

<b>new</b>	EKS 25-06	6	25	59	
<b>new</b>	EKS 25-08	8	25	59	
<b>new</b>	EKS 25-10	10	25	59	
<b>new</b>	EKS 25-12	12	25	59	
<b>new</b>	EKS 25-16	16	25	59	
<b>new</b>	EKS 25-20	20	25	59	



	EKS 32-06	6	32	65	
	EKS 32-08	8	32	65	
	EKS 32-10	10	32	65	
	EKS 32-12	12	32	65	
<b>new</b>	EKS 32-14	14	32	65	
	EKS 32-16	16	32	65	
<b>new</b>	EKS 32-18	18	32	65	
	EKS 32-20	20	32	65	
	EKS 32-25	25	32	65	

Komplettsatz : Seite 10.22  
Complete set : Page 10.22  
Kit complet : Voir page 10.22  
Komple set : Sayfa 10.22



## Spannzangen für Hyrodehnspannfutter

Reducing arbor for hydraulic expansions chuck

Douille de réduction pour mandrins expansibles hydrauliques

Hidrolik takım tutucu pensi

Bestell-Nr. Order Nr. Référence Sipariş Nr.	d	D	L	Euro
R12-030	3	12	46	
R12-040	4	12	46	
R12-050	5	12	46	
R12-060	6	12	46	
R12-080	8	12	46	

R20-030	3	20	52,5	
R20-040	4	20	52,5	
R20-050	5	20	52,5	
R20-060	6	20	52,5	
R20-080	8	20	52,5	
R20-100	10	20	52,5	
R20-120	12	20	52,5	
R20-140	14	20	52,5	
R20-160	16	20	52,5	

R32-060	6	32	63	
R32-080	8	32	63	
R32-100	10	32	63	
R32-120	12	32	63	
R32-140	14	32	63	
R32-160	16	32	63	
R32-200	20	32	63	
R32-250	25	32	63	

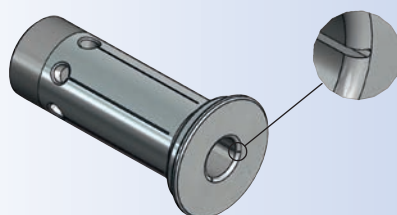
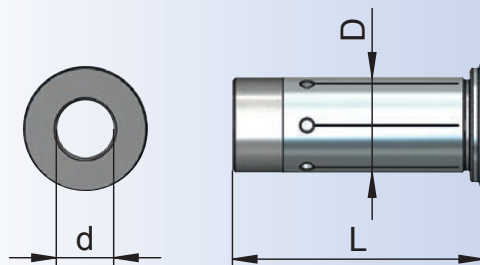

Kühlkanal-Bohrungen: Können als option bestellt werden  
(Beispiel Bestellnummer: R12-080.KKB)

Coolant Channels: Can be ordered as option  
(Example order code no: R12-080.KKB)

Conduits pour arrosage: Peuvent être commandés comme l'option  
(Exemple commande no: R12-080.KKB)

Soğutma kanalı: İsteğe bağlı alından su vermeli yapılabilir  
(Örnek sipariş no : R12-080.KKB)

Komplettsatz : Seite 10.22  
Complete set : Page 10.22  
Kit complet : Voir page 10.22  
Komple set : Sayfa 10.22

## Spannzangen für EPC-Spannfutter



### Reducing bushes for EPC-Collet Chucks

### Douille de reduction pour mandrin a pinces EPC

### Çektirmeli takım tutucu için pensler

	Bestell-Nr. Order Nr. Référence Sipariş Nr.	d	D1	D2	L	L1	Euro
new	EPC06.03	3	10,2	8	37,5	9	
new	EPC06.04	4	10,2	8	37,5	12	
new	EPC06.05	5	10,2	8	37,5	15	
new	EPC06.06	6	10,2	8	37,5	20	
new	EPC08.03	3	13,7	10,5	46,5	9	
new	EPC08.04	4	13,7	10,5	46,5	12	
new	EPC08.05	5	13,7	10,5	46,5	15	
new	EPC08.06	6	13,7	10,5	46,5	20	
new	EPC08.08	8	13,7	10,5	46,5	26	
new	EPC12.03	3	18,2	14,5	57,5	9	
new	EPC12.04	4	18,2	14,5	57,5	12	
new	EPC12.05	5	18,2	14,5	57,5	15	
new	EPC12.06	6	18,2	14,5	57,5	20	
new	EPC12.08	8	18,2	14,5	57,5	26	
new	EPC12.10	10	18,2	14,5	57,5	30	
new	EPC12.12	12	18,2	14,5	57,5	34	
new	EPC16.03	3	23,2	18,5	65,5	9	
new	EPC16.04	4	23,2	18,5	65,5	12	
new	EPC16.05	5	23,2	18,5	65,5	15	
new	EPC16.06	6	23,2	18,5	65,5	20	
new	EPC16.08	8	23,2	18,5	65,5	26	
new	EPC16.10	10	23,2	18,5	65,5	30	
new	EPC16.12	12	23,2	18,5	65,5	34	
new	EPC16.14	14	23,2	18,5	65,5	38	
new	EPC16.16	16	23,2	18,5	65,5	40	

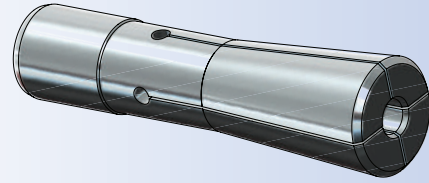
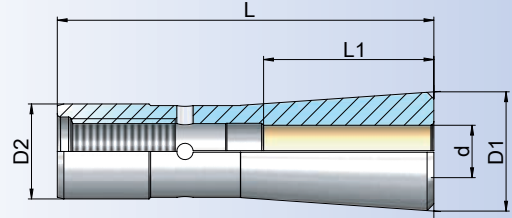



## Spannzangen für Hyrodehnspannfutter

### Reducing arbor for hydraulic expansions chuck

### Douille de réduction pour mandrins expansibles hydrauliques

### Hidrolik takım tutucu pensi

Bestell-Nr. Order Nr. Référence Sipariş Nr.	d	D	L	Euro
R20-0.1875IN	3/16"	20	52,5	
R20-0.25IN	1/14"	20	52,5	
R20-0.3125IN	5/16"	20	52,5	
R20-0.375IN	3/8"	20	52,5	
R20-0.4375IN	7/16"	20	52,5	
R20-0.5IN	1/2"	20	52,5	
R20-0.5625IN	9/16"	20	52,5	
R20-0.625IN	5/8"	20	52,5	
R32-0.5IN	1/2"	32	63	
R32-0.5625IN	9/16"	32	63	
R32-0.625IN	5/8"	32	63	
R32-0.6875IN	11/16"	32	63	
R32-0.75IN	3/4"	32	63	
R32-0.875IN	7/8"	32	63	
R32-1.0IN	1"	32	63	

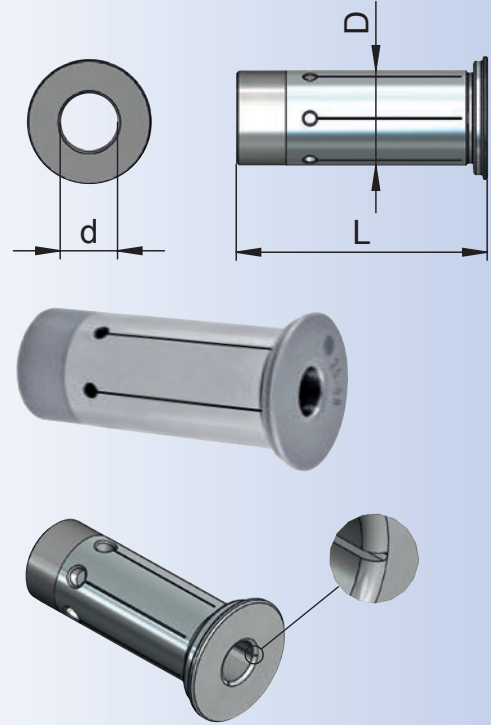

Kühlkanal-Bohrungen: Können als option bestellt werden  
(Beispiel Bestellnummer: R20-0.1875IN.KKB)

Coolant Channels: Can be ordered as option  
(Example order code no: R20-0.1875IN.KKB)

Conduits pour arrosage: Peuvent être commandés comme l'option  
(Exemple commande no: R20-0.1875IN.KKB)

Soğutma kanalı: İsteğe bağlı alından su vermeli yapılabilir  
(Örnek sipariş no : R20-0.1875IN.KKB)

## Koffer

### Case Plastic

### Valise de Plastique

### Plastik Kutu

Bestell-Nr. Order Nr. Référence Sipariş Nr.	Abmessung Size Dimension Cinsi	Bohrungen Holes Trous taraudés Delik Sayısı	B x H x L	Euro
* 701.05.1	ER8	9	90 x 30 x 95	
* 701.07.1	ER11	13	90 x 30 x 95	
* 701.10.1	ER16	10	110 x 45 x 115	
* 701.12.1	R12	5	210 x 72 x 255	
* 701.13.1	ER20	12	110 x 45 x 115	
701.16.1	ER25-OZ16	15	185 x 48 x 235	
701.20.1	ER32	18	230 x 83 x 275	
701.20.2	R20-EKS20	9	210 x 72 x 255	
701.25.1	OZ25	16	210 x 72 x 255	
701.26.1	ER40	23	275 x 83 x 340	
701.32.1	OZ32	16	275 x 83 x 340	
701.32.2	R32-EKS32	8	210 x 72 x 255	







## Spannzangensatz im Koffer

Collet set in box

Set de pinces dans valise

Pens takımı plastik kutusu ile birlikte



Bestell-Nr. Order Nr. Référéncé Sipariş Nr.	Stück Plece Pièce Adet	Koffer Case Plastic Valise de plastique Plastik Kutu	Abmessung Size Dimension Cinsi	Euro
415 E-S	OZ16 (15 St.)	701.16.1	2-3-4-5-6-7-8-9-10-11-12-13-14-15-16	
462 E-S	OZ25 (16 St.)	701.25.1	4-5-6-7-8-9-10-11-12-14-16-18-20-22-24-25	
467 E-S	OZ32 (16 St.)	701.32.1	5-6-7-8-10-12-14-16-18-20-22-24-25-28-30-32	
*4004 E-S	4004 E (ER8) (9 St.)	701.05.1	1-1,5-2-2,5-3-3,5-4-4,5-5	
*4008 E-S	4008 E (ER11) (13 St.)	701.07.1	1 -1,5-2-2,5-3-3,5-4-4,5-5-5,5-6-6,5-7	
*426 E-S	426 E (ER16) (10 St.)	701.10.1	1-2-3-4-5-6-7-8-9-10	
*428 E-S	428 E (ER20) (12 St.)	701.13.1	2-3-4-5-6-7-8-9-10-11-12-13	
430 E-S	430 E (ER25) (15 St.)	701.16.1	2-3-4-5-6-7-8-9-10-11-12-13-14-15-16	
470 E-S	470 E (ER32) (18 St.)	701.20.1	3-4-5-6-7-8-9-10-11-12-13-14-15-16-17-18-19-20	
472 E-S	472 E (ER40) (23 St.)	701.26.1	4-5-6-7-8-9-10-11-12-13-14-15-16-18-19-20-21 -22-23-24-25-26	



Bestell-Nr. Order Nr. Référéncé Sipariş Nr.	Stück Plece Pièce Adet	Koffer Case Plastic Valise de plastique Plastik Kutu	Abmessung Size Dimension Cinsi	Euro
EKS 20-S	EKS 20 (5 St.)	701.20.2	6-8-10-12-16	
EKS 32-S	EKS 32 (7 St.)	701.32.2	6-8-10-12-16-20-25	
* R12-S	R12 (5 St.)	701.12.1	3-4-5-6-8	
* R20-S	R20 (9 St.)	701.30.2	3-4-5-6-8-10-12-14-16	
* R32-S	R32 (8 St.)	701.32.2	6-8-10-12-14-16-20-25	



## Spannmutter OZ DIN 6388 D kugellagerte Ausführung

### Clamping nuts OZ DIN 6388 D ball-bearing version

### Écrou de serrage DIN 6388 D version rolument à billes

### Pens kapağı bilyeli tip DIN 6388 D

Bestell-Nr. Order Nr. Référence Sipariş Nr.	Abmessung Size Dimension Cinsi	D	Gewinde Tap Filet Diş	Euro
112.01.16	415 E	43	M33 x 1,5	
112.01.25	462 E	60	M48 x 2	
112.01.32	467 E	72	M 60 x 2,5	

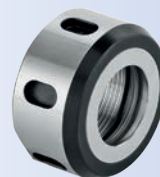
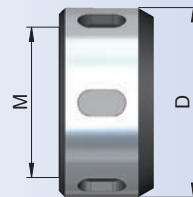

### Zubehör / Accessories / Accessoires / Yedekler



Hakenschlüssel  
Wrench  
Clé à ergot  
E tipi ay anahtar

## Spannmutter ER Mini

### Clamping Nut ER Mini

### Écrou ER Mini

### ER Mini Kapak

Bestell-Nr. Order Nr. Référence Sipariş Nr.	Abmessung Size Dimension Cinsi	D	Gewinde Tap Filet Diş	Euro
109.02.05	ER8	12	M10x0,75	
109.02.07	ER11	16	M13x0,75	
109.02.10	ER16	22	M19 x 1	

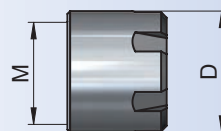

### Zubehör / Accessories / Accessoires / Yedekler



Rollenschlüssel für Spannmutter  
Roller Bearing Wrenches  
Cles à rouleaux  
Bilyalı Kapak Sıkma Anahtar



Spannschlüssel ER  
Wrench ER  
Clé de serrage ER  
Anahtar ER

## Spannmutter mit Außengewinde

### Clamping nut short

### Écrou de serrage court

### Gömme kapak

Bestell-Nr. Order Nr. Référence Sipariş Nr.	Abmessung Size Dimension Cinsi	SW	L	Gewinde Tap Filet Diş	Euro
<b>new</b> 110.02.10.D	ER16	19	11	M24 x 1,0	
<b>new</b> 110.02.16.D	ER25	24	14	M32 x 1,5	
<b>new</b> 110.02.20.D	ER32	30	16	M40 x 1,5	

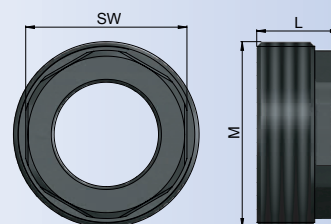

### Zubehör / Accessories / Accessoires / Yedekler



Spannschlüssel ER  
Wrench ER  
Clé de serrage ER  
Anahtar ER

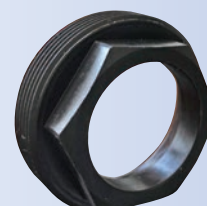



## Spannmutter ER DIN 6499 Standardausführung mit Exzenterring - gewuchtet

### Clamping nuts ER DIN 6499 - balanced

### Écrou de serrage ER DIN 6499 version standard avec bague excentrique - équilibré

### Pens kapağı ER tipi DIN 6499 Balanslı alınmış

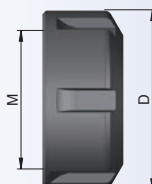
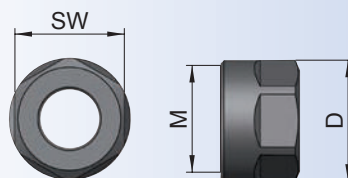

Bestell-Nr. Order Nr. Référence Sipariş Nr.	Abmessung Size Dimension Cinsi	D	SW	Gewinde Tap Filet Diş	Euro
* 110.02.07.6KT	ER11	19	17	M14 X 0,75	
* 110.02.10.6KT	ER16	28	25	M22 x 1,5	
110.02.10	ER16	30	-	M22 X 1,5	
* 110.02.13.6KT	ER20	34	30	M25 x 1,5	
110.02.16	ER25	42	-	M 32 x 1,5	
110.02.20	ER32	50	-	M40 x 1,5	
110.02.26	ER40	63	-	M50x 1,5	

- \* Sechskantmutter
- \* Six side clamping nuts
- \* Écrou à 6 pens
- \* 6 köşeli

## Spannmutter ER DIN 6499 kugelgelagerte Ausführung

### Clamping nuts ER DIN 6499 Ball-bearing version

### Écrou de serrage ER DIN 6499 version roulement à billes

### Pens kapağı ER tipi DIN 6499 Bilyalı tip

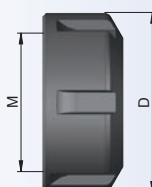
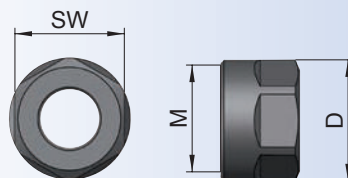

Bestell-Nr. Order Nr. Référence Sipariş Nr.	Abmessung Size Dimension Cinsi	D	SW	Gewinde Tap Filet Diş	Euro
* 112.02.10	ER16	30	27	M22 x 1,5	
112.02.13	ER20	35	-	M25 x 1,5	
112.02.16	ER25	42	-	M32 x 1,5	
112.02.20	ER32	50	-	M40 x 1,5	
112.02.26	ER40	63	-	M50 x 1,5	

- \* Sechskantmutter
- \* Six side clamping nuts
- \* Écrou à 6 pens
- \* 6 köşeli

### Zubehör / Accessories / Accessoires / Yedekler



Rollenschlüssel für Spannmutter  
Roller Bearing Wrenches  
Cles à rouleaux  
Bilyalı Kapak Sıkma Anahtar



Spannschlüssel ER  
Wrench ER  
Clé de serrage ER  
Anahtar ER



## Spannmutter OZ DIN 6388 D für Dichtscheiben

Clamping nuts OZ for sealing disc DIN 6388 D

Écrou de serrage OZ pour joints DIN 6388 D

Pens kapağı DIN 6388 D

Su sızdırmaz ringli içten soğutmalı takımlar için

Bestell-Nr. Order Nr. Référence Sipariş Nr.	Abmessung Size Dimension Cinsi	D	Gewinde Tap Filet Diş	Euro
113.01.16	415 E	43	M33 x 1,5	
113.01.25	462 E	60	M48 x 2	
113.01.32	467 E	72	M60 x 2,5	

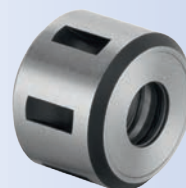
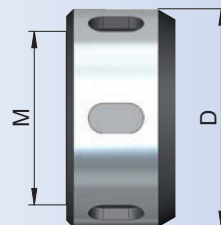

### Zubehör / Accessories / Accessoires / Yedekler



Hakenschlüssel  
Wrench  
Clé à ergot  
E tipi ay anahtar

## Spannmutter ER DIN 6499 für Dichtscheiben

Clamping nuts ER DIN 6499 for sealing disc

Écrou de serrage pour joints ER DIN 6499

Pens kapağı DIN 6499 ER tipi Su sızdırmaz ringli

Bestell-Nr. Order Nr. Référence Sipariş Nr.	Abmessung Size Dimension Cinsi	D	SW	Gewinde Tap Filet Diş	Euro
*113.02.10	ER16	28	25	M22 x 1,5	
113.02.16	ER25	42	-	M32 X 1,5	
113.02.20	ER32	50	-	M40 x 1,5	
113.02.26	ER40	63	-	M50 x 1,5	

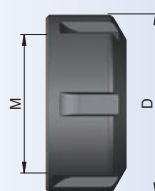
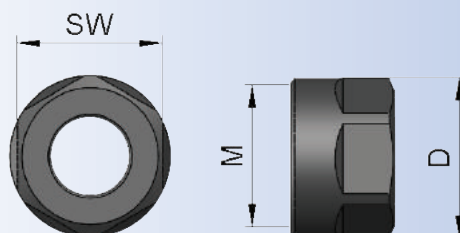

- \* Sechskantmutter
- \* Six side clamping nuts
- \* Ecrou à 6 pens
- \* 6 köşeli

### Zubehör / Accessories / Accessoires / Yedekler



Rollenschlüssel für Spannmutter  
Roller Bearing Wrenches  
Cles à rouleaux  
Bilyalı Kapak Sıkma Anahtar



Spannschlüssel ER  
Wrench ER  
Clé de serrage ER  
Anahtar ER





## Dichtscheiben für OZ Spannmuttern

Sealing disc for OZ clamping nuts

Jointes écrou de serrage OZ

Su sızdırmaz ringli içten soğutmalı takımlar için

Bestell-Nr. Order Nr. Référence Sipariş Nr.	d je 0,5 mm	D	Typ	Euro
01.16.XXX	3,0-6,0	20,3	415 E	
01.16.XXX	6,5-16,0			
01.25.XXX	3,0-6,0	29,8	462 E	
01.25.XXX	6,5-25,0			
01.32.XXX	3,0-6,0	38,3	467 E	
01.32.XXX	6,5-32,0			

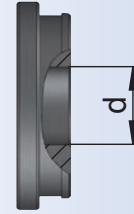

## Dichtscheiben für ER Spannmuttern

ER

Sealing Disc for ER clamping nuts

Jointes pour écrou de serrage ER

Su sızdırmaz ringli içten soğutmalı takımlar için

Bestell-Nr. Order Nr. Référence Sipariş Nr.	d je 0,5 mm	D	Typ	Euro
02.10.xxx	3,0 - 6,0	12,85	ER 16	
02.10.xxx	6,5-10,0			
02.16.xxx	3,0 - 6,0	20,80	ER 25	
02.16.xxx	6,5-16,0			
02.20.xxx	3,0 - 6,0	26,80	ER 32	
02.20.xxx	6,5 - 20,0			
02.26.xxx	3,0 - 6,0	33,30	ER 40	
02.26.xxx	6,5 - 26,0			

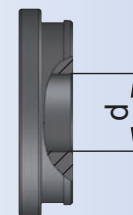



## Reduzierbuchse für Bohrstangenhalter

Reduction bushes for boring bar holder

Douille de réduction pour barre d'alésage

Delik kateri redüksiyonu

Bestell-Nr. Order Nr. Référence Sipariş Nr.	d	d1	L	L1	L2	a	Euro
709.25.06.45	25	6	45	5	35	10,5	
709.25.08.45	25	8	45	5	35	10,5	
709.25.10.45	25	10	45	5	35	10,5	
709.25.12.45	25	12	45	5	35	10,5	
709.25.14.45	25	14	45	5	35	10,5	
709.25.16.45	25	16	45	5	35	10,5	
709.25.18.45	25	18	45	5	35	10,5	
709.25.20.45	25	20	45	5	35	10,5	

709.32.06.65	32	6	65	5	45	10,5	
709.32.08.65	32	8	65	5	45	10,5	
709.32.10.65	32	10	65	5	45	10,5	
709.32.12.65	32	12	65	5	45	10,5	
709.32.14.65	32	14	65	5	45	10,5	
709.32.16.65	32	16	65	5	45	10,5	
709.32.18.65	32	18	65	5	45	10,5	
709.32.20.65	32	20	65	5	45	10,5	
709.32.25.65	32	25	65	5	45	10,5	

709.40.06.75	40	6	75	5	52	12,5	
709.40.08.75	40	8	75	5	52	12,5	
709.40.10.75	40	10	75	5	52	12,5	
709.40.12.75	40	12	75	5	52	12,5	
709.40.14.75	40	14	75	5	52	12,5	
709.40.16.75	40	16	75	5	52	12,5	
709.40.18.75	40	18	75	5	54	12,5	
709.40.20.75	40	20	75	5	54	12,5	
709.40.25.75	40	25	75	5	54	12,5	
709.40.32.75	40	32	75	5	54	12,5	

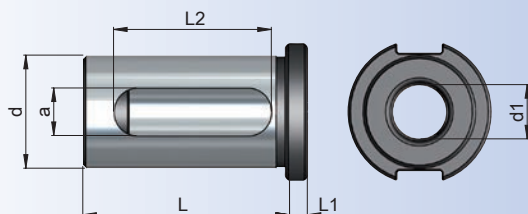

## Reduzierbuchse für Bohrstangenhalter



Reduction bushes for boring bar holder

Douille de réduction pour barre d'alésage

Delik kateri redüksiyonu

Bestell-Nr. Order Nr. Référence Sipariş Nr.	d	d1	L	L1	Type	Euro
709.25.06.1.46	25	6	46	4	1	
709.25.08.1.46	25	8	46	4	1	
709.25.10.1.46	25	10	46	4	1	
709.25.12.1.46	25	12	46	4	1	
709.25.14.1.46	25	14	46	4	2	
709.25.16.1.46	25	16	46	4	2	
709.25.18.1.46	25	18	46	4	2	
709.25.20.1.46	25	20	46	4	2	
709.32.06.1.53	32	6	53	5	1	
709.32.08.1.53	32	8	53	5	1	
709.32.10.1.53	32	10	53	5	1	
709.32.12.1.53	32	12	53	5	1	
709.32.14.1.53	32	14	53	5	1	
709.32.16.1.53	32	16	53	5	2	
709.32.18.1.53	32	18	53	5	2	
709.32.20.1.53	32	20	53	5	2	
709.32.25.1.53	32	25	53	5	2	
709.40.06.1.53	40	6	53	5	1	
709.40.08.1.53	40	8	53	5	1	
709.40.10.1.53	40	10	53	5	1	
709.40.12.1.53	40	12	53	5	1	
709.40.14.1.53	40	14	53	5	1	
709.40.16.1.53	40	16	53	5	1	
709.40.18.1.53	40	18	53	5	1	
709.40.20.1.53	40	20	53	5	1	
709.40.25.1.53	40	25	53	5	2	
709.40.32.1.53	40	32	53	5	2	

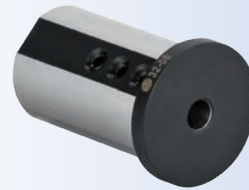
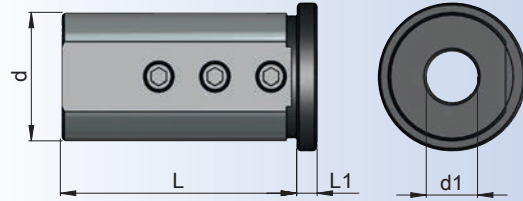

Type 1



Type 2



## Reduzierbuchse für Bohrstangenhalter

Reduction bushes for boring bar holder

Douille de réduction pour barre d'alésage

İç çap tornalama kater tutucu redüksiyonu

Bestell-Nr. Order Nr. Référence Sipariş Nr.	d	d1	L	L1	Type	Euro
709.32.06.1.80	32	6	80	5	1	
709.32.08.1.80	32	8	80	5	1	
709.32.10.1.80	32	10	80	5	1	
709.32.12.1.80	32	12	80	5	1	
709.32.14.1.80	32	14	80	5	1	
709.32.16.1.80	32	16	80	5	2	
709.32.18.1.80	32	18	80	5	2	
709.32.20.1.80	32	20	80	5	2	
709.32.25.1.80	32	25	80	5	2	

709.40.06.1.80	40	6	80	5	1	
709.40.08.1.80	40	8	80	5	1	
709.40.10.1.80	40	10	80	5	1	
709.40.12.1.80	40	12	80	5	1	
709.40.14.1.80	40	14	80	5	1	
709.40.16.1.80	40	16	80	5	1	
709.40.18.1.80	40	18	80	5	1	
709.40.20.1.80	40	20	80	5	1	
709.40.25.1.80	40	25	80	5	2	
709.40.32.1.80	40	32	80	5	2	

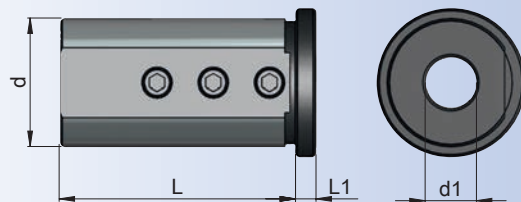

Type 1



Type 2





## Pull studs

## Tirettes

## Çektirme civataları

Bestell-Nr. Order Nr. Référence Sipariş Nr.	Abmessung Size Dimension Cinsi	D	M	l	L	d	d1	h	O - ring joint torique	
									X	Euro
401.20.16.S	S 20x2	S 20x2	M16	22	55	17	-	4	-	
*401.20.16.SK	M16	25	M16	28	53	21,1	7	13,7	-	
*401.20.16.BT	M16	25	M16	28	53	21,1	7	16,7	-	
*501.20.24.IK	M24	39,2	M24	40	65	32	7	13	-	

- \* Mit zusätzlichem Innengewinde
- \* With internal screw thread
- \* Avec Filet supplémentaire
- \* İçten çekirme dişi

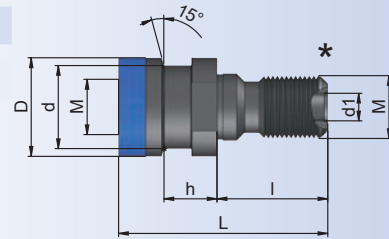
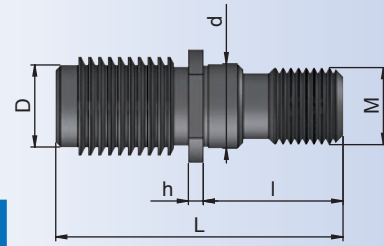

## Pull studs

## Tirettes

## Çektirme civataları

Bestell-Nr. Order Nr. Référence Sipariş Nr.	Type	D	M	l	L	d	d1	h	O - ring joint torique	
									X	Euro
302.20.12	DIN 69872-A	13	M12	20	44	9	-	19		
302.20.12.1	DIN 69872-A	12	M12	20	44	8	-	19		
402.20.16.IK	DIN 69872-A	19	M16	28	54	14	7	20	X	
405.20.16.4.IK	BT OKUMA-MAKINO	19	M16	25	54	14	4	23	X	
405.20.16.7.IK	BT	19	M16	25	54	14	7	23	X	
403.20.16	DIN 69872-A	19	M16	28	54	14	-	20	X	
502.20.24.IK	DIN 69872-A	28	M24	40	74	21	11,5	25	X	
503.20.24	DIN 69872-A	28	M24	40	74	21	-	25	X	

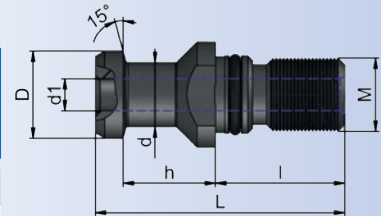



## Pull studs

## Tirettes

## Çektirme civataları

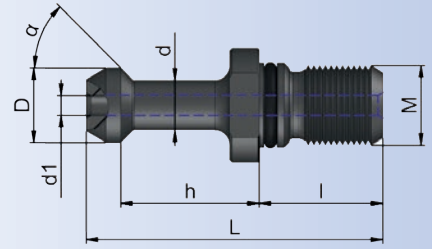

Bestell-Nr. Order Nr. Référéce Sipariş Nr.	D	M	$\alpha$	l	L	d	d1	h	O - ring joint torique X	Euro
305.20.45	11	M12	45°	20	43	7	-	18	-	
405.20.45	15	M16	45°	25	60	10	-	28	X	
505.20.45	23	M24	45°	40	85	17	-	35	X	
305.20.60	11	M12	60°	20	43	7	-	18	-	
405.20.60	15	M16	60°	25	60	10	-	28	X	
505.20.60	23	M24	60°	40	85	17	-	35	X	
305.20.90	11	M12	90°	20	43	7	-	18	-	
405.20.90	15	M16	90°	25	60	10	-	28	X	
505.20.90	23	M24	90°	40	85	17	-	35	X	
306.20.45.IK	11	M12	45°	20	43	8	2,5	18	X	
406.20.45.IK	15	M16	45°	25	60	10	3	28	X	
506.20.45.IK	23	M24	45°	40	85	17	6	35	X	
406.20.60.IK	15	M16	60°	25	60	10	3	28	X	
506.20.60.IK	23	M24	60°	40	85	17	6	35	X	
406.20.90.IK	15	M16	90°	25	60	10	3	28	X	
506.20.90.IK	23	M24	90°	40	85	17	6	35	X	
405.20.45.1	15	M16	45°	25	57	10	-	25	X	
406.20.45.1.IK	15	M16	45°	25	57	10	3	25	X	



Pull studs

Tirettes

Çektirme civataları

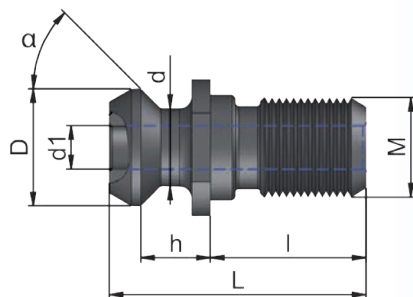

Bestell-Nr. Order Nr. Référence Sipariş Nr.	Type	D	M	$\alpha$	L	d	d1	l	h	O - ring joint torique X	Euro
404.20.16.IK	ISO 40	18,95	M16	45°	44,4	12,95	7,35	28	11,15	X	
504.20.24.IK	ISO 50	29,1	M24	45°	65,55	19,6	11,55	40	17,95	X	
407.20.16.IK	CAT 40 - MAZAK	18,796	M16	45°	41,256	12,446	7	25	11,176	-	
407.20.16.1.IK	BT 40-MAZAK	18,796	M16	45°	44,106	12,446	7	25	14,026	-	
507.20.24.IK	CAT 50 - MAZAK	28,956	M24	45°	65,4	20,828	10	40	17,78	-	
507.20.24.1.IK	BT 50 - MAZAK	28,956	M24	45°	65,2	20,828	10	40	17,58	-	



## Einsatz mit Rutschkupplung

M2 - M14

### Tapping collets with clutch

### Douille avec limiteur de couple

### Kılavuz tutucu emniyetli

Bestell-Nr. Order Nr. Référence Sipariş Nr.	M	D	d	L1	Ø	□	Euro
16.11.M02.2821	M2	32	19	24	2,8	2,1	
16.11.M25.2821	M2,5	32	19	24	2,8	2,1	
16.11.M03.3527	M3	32	19	24	3,5	2,7	
16.11.M35.0403	M3,5	32	19	24	4	3	
16.11.M04.4534	M4	32	19	24	4,5	3,4	
16.11.M04.2821	M4	32	19	24	2,8	2,1	
16.11.M05.0649	M5	32	19	24	6	4,9	
16.11.M05.3527	M5	32	19	24	3,5	2,7	
16.11.M06.4534	M6	32	19	24	4,5	3,4	
16.11.M06.0649	M6	32	19	24	6	4,9	
16.11.M08.0862	M8	32	19	24	8	6,2	
16.11.M08.0649	M8	32	19	24	6	4,9	
16.11.M10.0755	M10	32	19	24	7	5,5	
16.11.M10.1008	M10	32	19	24	10	8	
16.11.M12.0907	M12	32	19	24	9	7	
16.11.M14.1109	M14	32	19	24	11	9	

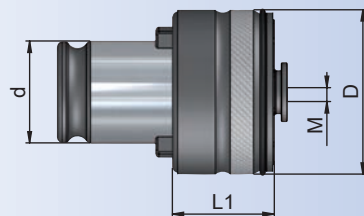

## Einsatz ohne Rutschkupplung

M2 - M14

### Tapping collets without clutch

### Douille sans limiteur de couple

### Kılavuz tutucu emniyetsiz

Bestell-Nr. Order Nr. Référence Sipariş Nr.	M	D	d	L1	Ø	□	Euro
16.01.2821	M2 - M2,2 - M2,5 - M4	30	19	6	2,8	2,1	
16.01.3527	M3 - M5	30	19	6	3,5	2,7	
16.01.0403	M3,5	30	19	6	4	3	
16.01.4534	M4 - M6	30	19	6	4,5	3,4	
16.01.0649	M5 - M6 - M8	30	19	6	6	4,9	
16.01.0862	M8	30	19	6	8	6,2	
16.01.0755	M10	30	19	6	7	5,5	
16.01.1008	M10	30	19	6	10	8	
16.01.0907	M12	30	19	6	9	7	
16.01.1109	M14	30	19	6	11	9	

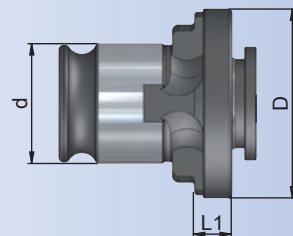



## Tapping collets with clutch

## Douille avec limiteur de couple

## Kılavuz tutucu emniyetli

Bestell-Nr. Order Nr. Référence Sipariş Nr.	M	D	d	L1	Ø	□	Euro
16.12.M05.0649	M5	50	31	31	6	4,9	
16.12.M06.0649	M6	50	31	31	6	4,9	
16.12.M08.0862	M8	50	31	31	8	6,2	
16.12.M08.0649	M8	50	31	31	6	4,9	
16.12.M10.0755	M10	50	31	31	7	5,5	
16.12.M10.1008	M10	50	31	31	10	8	
16.12.M12.0907	M12	50	31	31	9	7	
16.12.M14.1109	M14	50	31	31	11	9	
16.12.M16.1209	M16	50	31	31	12	9	
16.12.M18.1411	M18	50	31	31	14	11	
16.12.M20.1612	M20	50	31	31	16	12	
16.12.M22.18145	M22	50	31	31	18	14,5	
16.12.M24.18145	M24	50	31	31	18	14,5	

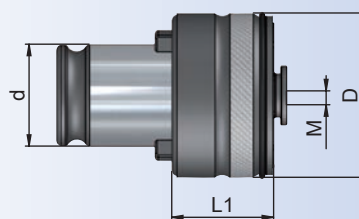

## Einsatz ohne Rutschkupplung

## M5 - M24

## Tapping collets without clutch

## Douille sans limiteur de couple

## Kılavuz tutucu emniyetsiz

Bestell-Nr. Order Nr. Référence Sipariş Nr.	M	D	d	L1	Ø	□	Euro
16.02.0649	M5 - M6 - M8	46,5	31	8,5	6	4,9	
16.02.0862	M8	46,5	31	8,5	8	6,2	
16.02.0755	M10	46,5	31	8,5	7	5,5	
16.02.1008	M10	46,5	31	8,5	10	8	
16.02.0907	M12	46,5	31	8,5	9	7	
16.02.1109	M14	46,5	31	8,5	11	9	
16.02.1209	M16	46,5	31	8,5	12	9	
16.02.1411	M18	46,5	31	8,5	14	11	
16.02.1612	M20	46,5	31	8,5	16	12	
16.02.18145	M22 - M24	46,5	31	8,5	18	14,5	

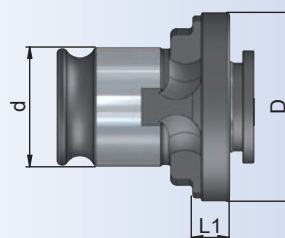



## Einsatz mit Rutschkupplung

M14 - M36

Tapping collets with clutch

Douille avec limiteur de couple

Kilavuz tutucu emniyetli

Bestell-Nr. Order Nr. Référence Sipariş Nr.	M	D	d	L1	Ø	□	Euro
16.13.M14.1109	M14	72	48	41	11	9	
16.13.M16.1209	M16	72	48	41	12	9	
16.13.M18.1411	M18	72	48	41	14	11	
16.13.M20.1612	M20	72	48	41	16	12	
16.13.M22.18145	M22	72	48	41	18	14,5	
16.13.M24.18145	M24	72	48	41	18	14,5	
16.13.M27.2016	M27	72	48	41	20	16	
16.13.M30.2218	M30	72	48	41	22	18	
16.13.M33.2520	M33	72	48	41	25	20	
16.13.M36.2822	M36	72	48	41	28	22	

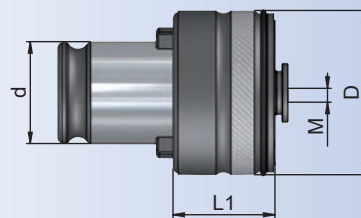

## Einsatz ohne Rutschkupplung

M14 - M36

Tapping collets without clutch

Douille sans limiteur de couple

Kilavuz tutucu emniyetsiz

Bestell-Nr. Order Nr. Référence Sipariş Nr.	M	D	d	L1	Ø	□	Euro
16.03.1109	M14	68	48	11	11	9	
16.03.1209	M16	68	48	11	12	9	
16.03.1411	M18	68	48	11	14	11	
16.03.1612	M20	68	48	11	16	12	
16.03.18145	M22 - M24	68	48	11	18	14,5	
16.03.2016	M27	68	48	11	20	16	
16.03.2218	M30	68	48	11	22	18	
16.03.2520	M33	68	48	11	25	20	
16.03.2822	M36	68	48	11	28	22	

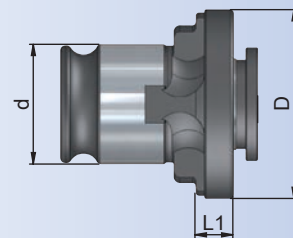

## Gewindebohrerhalter mit Zylinderschaft DIN 1835 B, ohne Rutschkupplung



Tap holder with cylindrical shank DIN 1835 B without clutch

Porte-taraud avec queue cylindrique DIN 1835 B sans limiterur de couple

Silindirik şaftlı kılavuz tutucu emniyetsiz

Bestell-Nr. Order Nr. Référence Sipariş Nr.	M	D	L	d	□	Euro
16.16.3527.56	M3 - M5	16	56	3,5	2,7	
16.16.0403.56	M3,5	16	56	4	3	
16.16.4534.56	M4 - M6	16	56	4,5	3,4	
16.16.0649.56	M5 - M6 - M8	16	56	6	4,9	

16.20.4534.58	M4 - M6	20	58	4,5	3,4	
16.20.0649.58	M5 - M6 - M8	20	58	6	4,9	
16.20.0862.58	M8	20	58	8	6,2	
16.20.0755.58	M10	20	58	7	5,5	
16.20.1008.58	M10	20	58	10	8	
16.20.0907.58	M12	20	58	9	7	

16.25.4534.66	M4 - M6	25	66	4,5	3,4	
16.25.0649.66	M5 - M6 - M8	25	66	6	4,9	
16.25.0862.66	M8	25	66	8	6,2	
16.25.0755.66	M10	25	66	7	5,5	
16.25.1008.66	M10	25	66	10	8	
16.25.0907.66	M12	25	66	9	7	
16.25.1109.66	M14	25	66	11	9	
16.25.1209.66	M16	25	66	12	9	

16.32.0649.70	M5 - M6 - M8	32	70	6	4,9	
16.32.0862.70	M8	32	70	8	6,2	
16.32.0755.70	M10	32	70	7	5,5	
16.32.1008.70	M10	32	70	10	8	
16.32.0907.70	M12	32	70	9	7	
16.32.1109.70	M14	32	70	11	9	
16.32.1209.70	M16	32	70	12	9	
16.32.1411.70	M18	32	70	14	11	
16.32.1612.70	M20	32	70	16	12	
16.32.18145.70	M22 - M24	32	70	18	14,5	

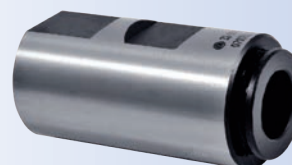
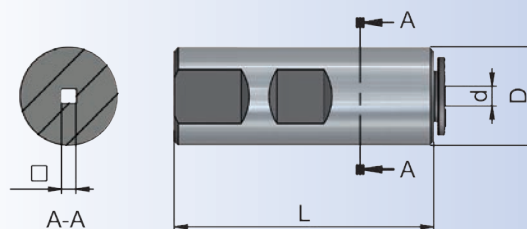



## Spannschraube für Weldon Spannfutter DIN 1835 B

Clamping screw weldon DIN 1835 B

Vis de serrage weldon DIN 1835 B

Veldon sıkma civatası DIN 1835 B

Bestell-Nr. Order Nr. Référence Sipariş Nr.	Abmessung Size Dimension Cinsi	DIN 1835 M	L	Veldon Ø	Euro
160.M06.100.010	-	M6	10	6	
160.M08.125.010	-	M8	10	8	
160.M10.150.012	-	M10	12	10	
160.M12.175.016	-	M12	16	12-14	
160.M14.200.016	-	M14	16	16-18	
160.M16.200.016	-	M16	16	20	
160.M18.200.020	-	M18x2	20	25	
160.M20.200.020	-	M20x2	20	32-40	

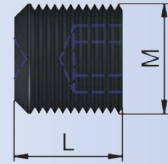

160.M14.200.016	402.04.16.35	M14	16	16	
	405.04.16.35				
160.M16.200.014	405.04.20.35	M16	14	20	
160.M16.200.016	402.04.20.35	M16	16	20	

Bestell-Nr. Order Nr. Référence Sipariş Nr.	Abmessung Size Dimension Cinsi	DIN 913 M	L	Veldon Ø	Euro
161.M16.100.008	402.04.25.35	M16x1	8	25	
	405.04.25.35				
161.M16.100.012	402.04.25.35	M16x1	12	25	
	405.04.25.35				
161.M16.100.008	402.04.32.65	M16x1	8	32	
	405.04.32.65	M16x1			
161.M16.100.010	402.04.32.65	M16x1	10	32	
161.M16.100.014	405.04.32.65	M16x1	14	32	

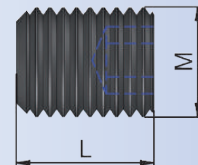





## Spannschraube

Clamping screw

Vis de serrage

Sıkma civatası

Bestell-Nr. Order Nr. Référence Sipariş Nr.	DIN 913 M	L	Form E1 d2	Euro
161.M10.100.012	M10x1	12	Ø16 - Ø20	
161.M12.100.012	M12x1	12	Ø25 - Ø32	
161.M16.100.012	M16x1	12	Ø40 - Ø50	

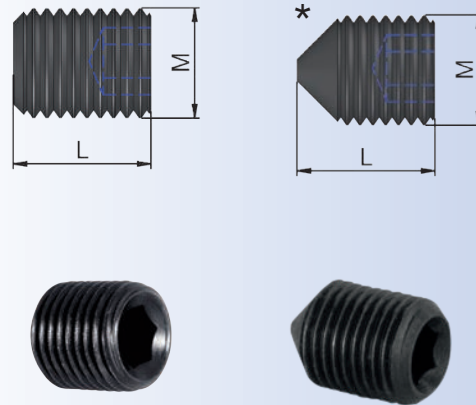

## Einstellschraube

Adjustment screw

Vis de réglage

Ayar civatası

Bestell-Nr. Order Nr. Référence Sipariş Nr.	DIN 915 M	L	ARF-Plus	Euro
166.M06.100.012	M6	12	SK-BT-HSK-EPS	
166.M06.100.020	M6	20	SK-BT-HSK-EPS	

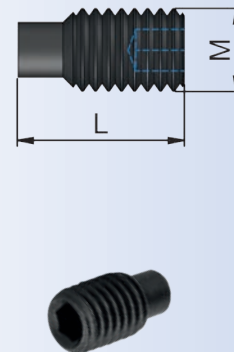

## Anzugsschraube

Bolt

Tirette

Civata

Bestell-Nr. Order Nr. Référence Sipariş Nr.	DIN 912 M	L	ARF-Plus	Euro
163.M06.100.020	M6	20	SK-BT-HSK-EPS	

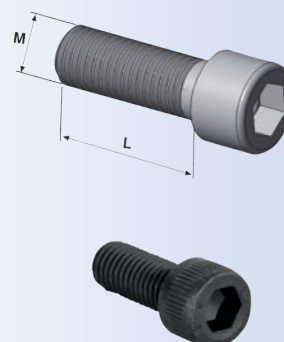



## Spannschraube

Clamping screw

Vis de serrage

Sıkma civatası

Bestell-Nr. Order Nr. Référence Sipariş Nr.	DIN 913 M	L	Form E2 d1xd2	Euro
161.M06.100.012	M6	12	16x06 16x08	
161.M06.100.010	M6	10	16x10	
161.M08.125.012	M8	12	16x12	
161.M08.125.010	M8	10	16x16	
161.M06.100.016	M6	16	20x08	
161.M06.100.014	M6	14	20x10	
161.M08.125.014	M8	14	20x12	
161.M08.125.012	M8	12	20x16 20x20	
161.M08.125.010	M8	10	20x25	
161.M06.100.016	M6	16	25x08	
161.M06.100.014	M6	14	25x10	
161.M08.125.014	M8	14	25x12	
161.M08.125.012	M8	12	25x16	
161.M08.125.014	M8	14	25x20	
161.M08.125.012	M8	12	25x25	
161.M06.100.012	M6	12	30x08 30x10	
161.M08.125.012	M8	12	30x12	
161.M08.125.018	M8	18	30x16	
161.M08.125.016	M8	16	30x20	
161.M08.125.012	M8	12	30x32	
161.M10.150.012	M10	12	30x40	
161.M06.100.012	M6	12	40x08 40x10 40x12	
161.M10.150.018	M10	18	40x16	
161.M10.150.016	M10	16	40x20	
161.M10.150.014	M10	14	40x25	
161.M10.150.016	M10	16	40x32	
161.M10.150.012	M10	12	40x40	

Bestell-Nr. Order Nr. Référence Sipariş Nr.	DIN 913 M	L	Form E2 d1xd2	Euro
161.M08.125.016	M8	16	50x12	
161.M10.150.016	M10	16	50x16	
161.M12.175.014	M12	14	50x20 50x25	
161.M12.175.020	M12	20	50x32	
161.M12.175.016	M12	16	50x40	
161.M12.175.012	M12	12	50x50	

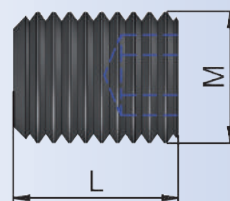

## Anschlagschraube



### Stop screw

### Vis ajuster

### Dayama civatası

Bestell-Nr. Order Nr. Référéncé Sipariş Nr.	DIN 916 M	L	SK-BT Whistle Notch Ø	Euro
165.1.M05.080.016	M5	16	6	
165.1.M06.100.016	M6	16	8	
165.1.M08.125.020	M8	20	10	
165.1.M10.150.025	M10	25	12-14	
165.1.M12.175.025	M12	25	16-18	
165.1.M16.200.025	M16	25	20	
165.1.M20.250.030	M20	30	25-32-40	

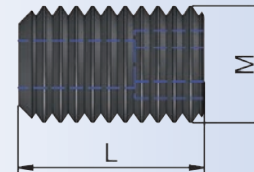

Bestell-Nr. Order Nr. Référéncé Sipariş Nr.	DIN 916 M	L	HSK A Whistle Notch Ø	Euro
165.1.M05.080.016	M5	16	6	
165.1.M06.100.016	M6	16	8	
165.1.M08.125.016	M8	16	10	
165.1.M10.150.016	M10	16	12-14	
165.1.M12.175.016	M12	16	16-18	
165.1.M12.175.020	M12	20	20-25-32	
165.1.M12.175.012	M12	12	40	

Bestell-Nr. Order Nr. Référéncé Sipariş Nr.	DIN 916 M	L	HSK C Whistle Notch Ø	Euro
165.1.M05.080.012	M5	12	6	
165.1.M06.100.012	M6	12	8	
165.1.M08.125.012	M8	12	10	
165.1.M10.150.012	M10	12	14	
165.1.M12.175.012	M12	12	16-18-20	
165.1.M12.175.016	M12	16	25-32	



## Anchlagschraube

Stop screw

Vis ajuster

Dayama civatası

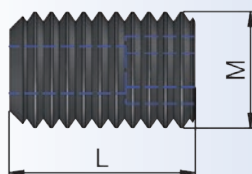

Bestell-Nr. Order Nr. Référence Sipariş Nr.	DIN 916 M	L	Shirink Ø	Abmessung Size Dimension Cinsi	Euro
165.1.M04.070.010	M4	10	03	HSK32	
165.1.M05.080.016	M5	16		SK30/HSK40-50-63/EPS63	
165.1.M06.100.016	M6	16		SK40-50/BT30-40-50	
165.1.M05.080.016	M5	16	03 Slim	SK/BT/HSK/EPS	
165.1.M04.070.010	M4	10	04	HSK32	
165.1.M05.080.016	M5	16		HSK40	
165.1.M06.100.016	M6	16		SK/BT/HSK50-63/EPS63	
165.1.M05.080.016	M5	16	04 Slim	SK40-50/BT40-50	
165.1.M06.100.016	M6	16		HSK63/EPS63	
165.1.M04.070.010	M4	10	05	HSK32-40	
165.1.M06.100.016	M6	16		SK/BT/HSK50-63/EPS63	
165.1.M06.100.016	M6	16	05 Slim	SK/BT/HSK/EPS	
165.1.M05.080.016	M5	16	06	SK/BT/HSK/EPS	
			06 Slim		
165.1.M06.100.016	M6	16	08	SK/BT/HSK/EPS	
			08 Slim		
165.1.M08.125.008	M8	8	10	HSK32	
165.1.M08.125.016	M8	16		SK/BT/HSK40-50-63-80-100/EPS50-63	
165.1.M08.125.010	M8	10	10 Slim	SK/BT/HSK/EPS	
			12	HSK32	
165.1.M10.150.016	M10	16	12 Slim	SK/BT/HSK40-50-60-80-100/EPS	
165.1.M10.150.016	M10	16	14	SK/BT/HSK/EPS	
165.1.M10.150.010	M10	10	16	HSK40-50	
165.1.M10.150.016	M10	16		EPS40-50	
165.1.M12.175.016	M12	16		SK/BT/EPS63-80	
165.1.M12.175.016	M12	16	16 Slim	HSK100	
			18	SK/BT/HSK/EPS	
			20	SK/BT/HSK/EPS	
			25	SK/BT/HSK/EPS	
165.1.M16.200.020	M16	20	32	HSK63-80-100/EPS50-63-80	
				SK/BT	

## Anschlagschraube



Stop screw

Vis ajuster

Dayama civatası

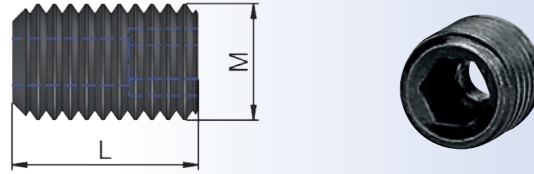

Bestell-Nr. Order Nr. Référence Sipariş Nr.	DIN 916 M	L	Hydraulic Ø	Abmessung Size Dimension Cinsi	Euro
165.1.M05.080.006	M5	6	06	HSK100/EPS63	
165.1.M05.080.010	M5	10		HSK40-50-60/EPS50	
165.1.M05.080.016	M5	16		SK/BT/EPS40	
165.1.M06.100.006	M6	6	08	HSK50-63-100/EPS50-63	
165.1.M06.100.016	M6	16		SK/BT/HSK63 Long	
165.1.M08.125.010	M8	10	10	HSK50-63/EPS63	
165.1.M08.125.016	M8	16		SK/BT/HSK63 Long-100/EPS40-50	
165.1.M10.150.010	M10	10	12	HSK40-50-63	
165.1.M10.150.016	M10	16		SK/BT/HSK63 Long-100	
165.1.M10.150.010	M10	10	14	HSK40-50-63	
165.1.M10.150.016	M10	16		SK/BT/HSK63 Long-100/EPS50-63	
165.1.M12.175.010	M12	10	16	HSK40-50-63	
165.1.M12.175.016	M12	16		SK/BT/HSK63 Long-100/EPS50-63	
165.1.M12.175.010	M12	10	18	HSK40-50-63	
165.1.M12.175.016	M12	16		SK/BT/HSK63 Long-100/EPS50-63	
165.1.M08.100.008	M8x1	8	20	A63.65.20.80	
165.1.M10.150.010	M10	10		HSK50	
165.1.M10.150.012	M10	12		EPS63	
165.1.M10.150.016	M10	16		EPS50	
165.1.M12.175.010	M12	10		HSK63/403.65.20.64/406.65.20.72	
165.1.M12.175.016	M12	16		HSK63 Long-100	
165.1.M12.175.020	M12	20		SK/BT/EPS80	
165.1.M12.175.016	M12	16	25	EPS50-63	
165.1.M16.200.016	M16	16		SK/BT/HSK	
165.1.M12.175.010	M12	10	32	503.65.32.81	
165.1.M12.100.012	M12x1	12		506.65.32.90	
165.1.M16.200.016	M16	16		SK/BT/HSK/EPS	



## Paßfeder

### Feather Key

### Ressort de passage

### Kama

Bestell-Nr. Order Nr. Référence Sipariş Nr.	h b L	DIN 913	Euro
10.16.4	4 x 4 x 20	M2x4	
10.22.6	6 x 6 x 25	M3 x 5	
10.27.7	7 x 7 x 25	M3 x 6	
10.32.8	8 x 7 x 28	M3 x 6	
10.40.10	10 x 8 x 32	M3 x 6	

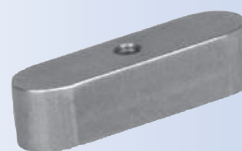

## Mitnehmersteine mit Schraube

### Drive Key

### Entraineur

### Vidalı kama

Bestell-Nr. Order Nr. Référence Sipariş Nr.	b L h	DIN 912	Euro
11.16.8	8 x 10x9,8	M3 x 12	
11.22.10	10 x 11 x 11,2	M4 x 12	
11.27.12	12 x 14x 12,6	M4 x 16	
11.32.14	14 x 22 x 14	M5 x 16	
11.40.16	16 x 23 x 16	M5 x 20	
11.50.18	18 x 32 x 18	M6 x 20	
11.60.25	25,4 x 26,5 x 25	M12 x 25	

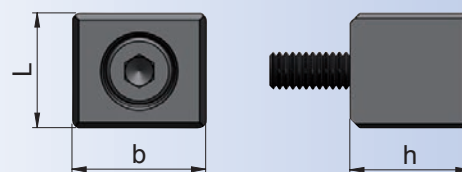

## Unterlegplatte

VDI 3425

### Shim

### Plaque entretoise

### Kater laması

Bestell-Nr. Order Nr. Référence Sipariş Nr.	B x H x L	Euro
169.12.01	10 x 3,95 x 41	
209.16.01	13 x 3,95 x 49	
309.20.01	17 x 3,95 x 69	
409.25.01	21 x 4,95 x 84	
509.32.01	24 x 6,95 x 99	

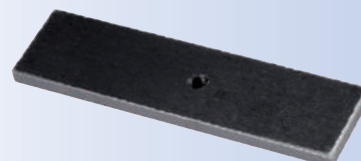
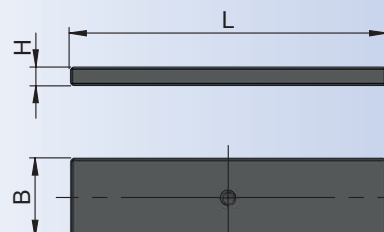

## Fräseranzugsschrauben DIN 6367



Drawn in bolt DIN 6367

Vis de serrage DIN 6367

Tarama başlık sıkma civataası DIN 6367

Bestell-Nr. Order Nr. Référence Sipariş Nr.	Abmessung Size Dimension Cinsi	M	D	K	L	Euro
102.10.16	16	M8	20	6	16	
102.10.22	22	M10	28	7	18	
102.10.27	27	M12	35	8	22	
102.10.32	32	M16	42	9	26	
102.10.40	40	M20	52	10	30	
102.10.50	50	M24	63	12	36	
102.10.60	60	M30	75	14	45	

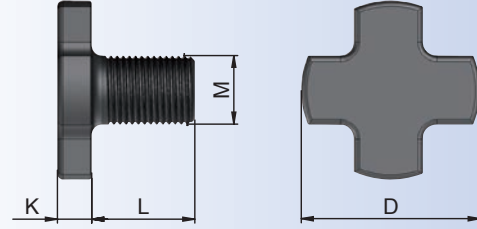

## Fräseranzugsschrauben DIN 6367 durchgebohrt für Kühlmittelzufuhr

Drawn in bolt bored through for coolant DIN 6367

Vis de serrage DIN 6367 percée pour l'arrosage par la collerette

Tarama başlık sıkma civataası DIN 6367 içten soğutmalı

Bestell-Nr. Order Nr. Référence Sipariş Nr.	Abmessung Size Dimension Cinsi	M	D	K	L	Euro
102.11.16	16	M8	20	6	16	
102.11.22	22	M10	28	7	18	
102.11.27	27	M12	35	8	22	
102.11.32	32	M16	42	9	26	
102.11.40	40	M20	52	10	30	
102.11.50	50	M24	63	12	36	
102.11.60	60	M30	75	14	45	

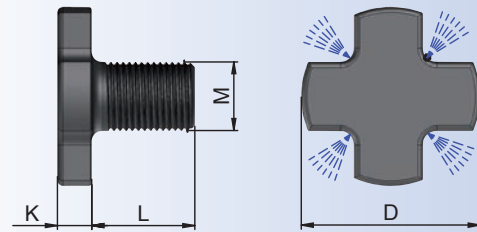



## Mitnehmerringe DIN 6366

Clutch drive rings to DIN 6366

Bague d'entraînement DIN 6366

Tırnaklı pul DIN 6366

Bestell-Nr. Order Nr. Référence Sipariş Nr.	d	D	a	b	h	Euro
101.10.16	16	32	10	8	5	
101.10.22	22	40	12	10	5,6	
101.10.27	27	48	12	12	6,3	
101.10.32	32	58	14	14	7	
101.10.40	40	70	14	16	8	

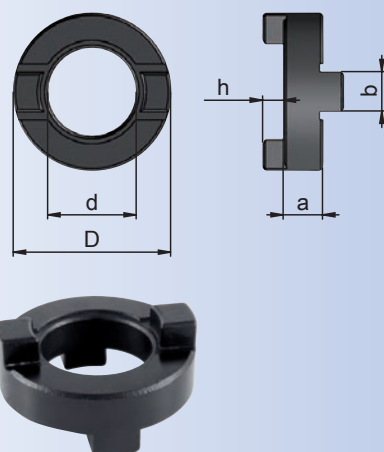

## Spannschlüssel DIN 6368 für Aufsteckdorne

Wrench DIN 6368

Clé de serrage DIN 6368

Tarama başlık civatası sıkma anahtarı DIN 6368

Bestell-Nr. Order Nr. Référence Sipariş Nr.	D	Euro
10.16	16/M8	
10.22	22/M10	
10.27	27/M12	
10.32	32/M16	
10.40	40 / M20	
10.50	50 / M24	
10.60	60 / M30	



## Hakenschlüssel DIN 1810 A für OZ - Spannmuttern

Wrench DIN 1810 A

Clé à ergot DIN 1810 A

E tipi ay anahtar DIN 1810 A

Bestell-Nr. Order Nr. Référence Sipariş Nr.	Abmessung Size Dimension Cinsi	D	Euro
01.16	415 E (2-16)	40-42	
01.25	462 E (2-25)	58-62	
01.32	467 E (3-32)	68-75	

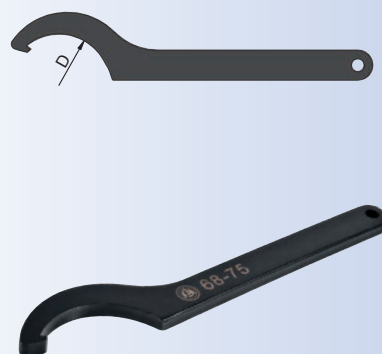





## Rollenschlüssel für ER - Spanmuttern / Präzisionskartstpannfutter

### Wrench for ER - Precision milling chuck

### Clé pour ER - Mandrin de fraisage de précision

### ER tipi ve bilyalı pens tutucu için anahtar

Bestell-Nr. Order Nr. Référence Sipariş Nr.	Abmessung Size Dimension Cinsi	D	Euro
02.05.10	ER 8 (1-5)	10	
<b>new</b> 02.05.12	ER 8 (1-5)	12	
02.07.16	ER 11 (1-7)	16	
02.10.22	ER 16 (1-10)	22	
02.10.24	ER 16 (1-10)	24	
02.10.30	ER 16(1-10)	30	
02.10.32	ER 16 (1-10)	32	
02.13.35	ER 20 (1-13)	35	
02.16.40	ER 25 (2-16)	40	
02.16.42	ER 25 (2-16)	42	
02.20.50	ER 32 (2-20)	50	
02.26.63	ER 40 (3-26)	63	
03.20.N	EKS 20 (16-20)	48	
<b>new</b> 03.25.N	EKS 25 (16-25)	61	
03.32.N	EKS 32 (16-32)	68	

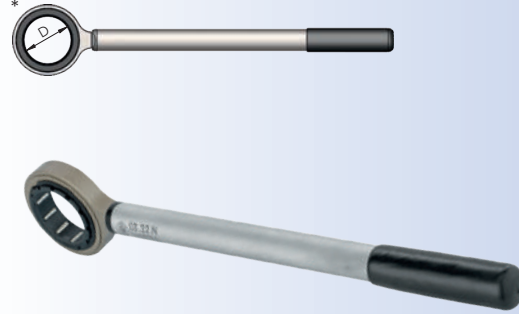

## Angetriebene werkzeuge spannschlüssel für spanmuttern

### Driven Tools wrench

### Porte-outils motorise clé de serrage

### Tahrikli takım anahtarları

Bestell-Nr. Order Nr. Référence Sipariş Nr.	SW	Euro
<b>new</b> AA36-00K	36	
<b>new</b> AA41-00K	41	
<b>new</b> AA50-00K	50	
<b>new</b> AA15-00	15	
<b>new</b> AA30-00	30	
<b>new</b> AA36-00	36	
<b>new</b> AA41-00	41	
<b>new</b> AA50-00	50	
<b>new</b> AA55-00	55	





## Spannschlüssel für ER Spannmuttern

Wrench ER

Clé de serrage ER

ER tipi anahtar

Bestell-Nr. Order Nr. Référence Sipariş Nr.	Abmessung Size Dimension Cinsi	D	Euro
*02.10	1 - 10 (ER16)	28 sw 25	
02.10.1	1 - 10 (ER16)	32	
*02.10.2	1 - 10 (ER16)	30 sw 27	
02.13	1 - 13 (ER20)	35 sw 30	
02.13.1	1 - 13 (ER20)	35	
02.16	2 - 16 (ER25)	42	
02.20	2 - 20 (ER32)	50	
02.26	3 - 26 (ER40)	63	



## Spannschlüssel für ER Mini

Wrench ER Mini

Clé de serrage ER Mini

ER tipi anahtar mini

Bestell-Nr. Order Nr. Référence Sipariş Nr.	Abmessung Size Dimension Cinsi	D	Euro
02.05.M	1 - 5 (ER8)	12	
02.07.M	1-7 (ER11)	16	
02.10.M	1 - 10 (ER16)	22	

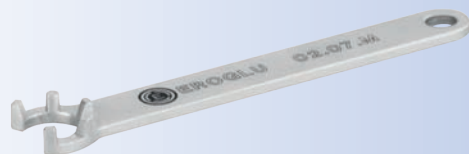

## Ausziehschlüssel für Reduzierhülsen der Hydrodehnspannfutter

Wrench reducing arbor for hydraulic expansion chuck

Clé pour les douilles de réduction pour les mondriens expansibles hydraulique

Hidrolik pens sökme anahtarı

Bestell-Nr. Order Nr. Référence Sipariş Nr.	Abmessung Size Dimension Cinsi	Euro
65.01	R12 / R20 / R32	





## Spanschlüssel

### Wrench

### Clé de serrage

### Sıkma anahtarı

Bestell-Nr. Order Nr. Référence Sipariş Nr.	SW	Typ	L	Euro
15.04	4	NC	100	
15.06	6	NC	100	
65.05	5	HDS	100	

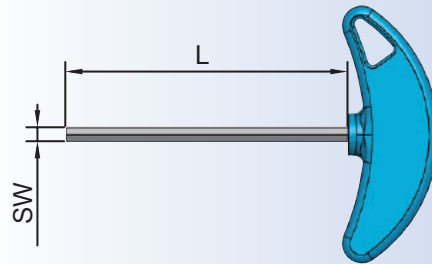

## Bohrfutter

### Drill chuck

### Mandrin de perçage á serrage

### Süper supra mandren

Bestell-Nr. Order Nr. Référence Sipariş Nr.	B	Spannbereich Capacity Capacité Kapasite	D	L	Euro
14.13.B16	B16	0-13	50	92	
14.16.B16	B16	3-16	57	95	

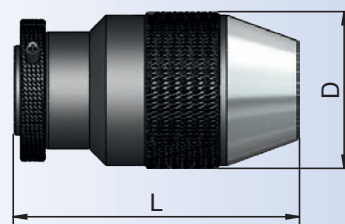



## Kühlmittelübergabeeinheit

Delivery unit for coolant

Unité de transmission de liquide de refroidissement par le centre

Soğutma suyu ünitesi

Bestell-Nr. Order Nr. Référence Sipariş Nr.	HSK-A	D	d	L	Euro
A32.700	HSK-A 32	M10 x 1	6	26,0	
A40.700	HSK-A 40	M12 x 1	8	29,5	
A50.700	HSK-A 50	M16 x 1	10	33,0	
A63.700	HSK-A 63	M18 x 1	12	36,5	
A80.700	HSK-A 80	M20 x 1,5	14	40,0	
A100.700	HSK-A 100	M24 x 1,5	16	44,0	

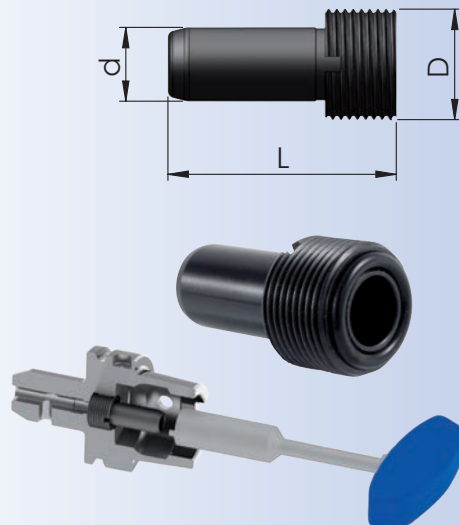

## Schlüssel für Kühlmittelübergabeeinheit

Wrench for delivery unit for coolant

Clé pour raccord d'arrodage

Soğutma suyu ünitesi anahtarı

Bestell-Nr. Order Nr. Référence Sipariş Nr.	HSK-A	D	L	Euro
A32.701	HSK-A 32	8,5	115	
A40.701	HSK-A 40	10,5	115	
A50.701	HSK-A 50	14,5	115	
A63.701	HSK-A 63	16,5	136	
A80.701	HSK-A 80	18,5	136	
A100.701	HSK-A 100	22,0	136	

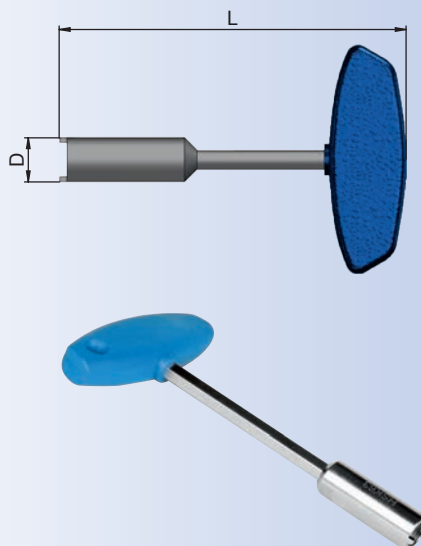

## Kunststoff - Kugelspritzdüse

Plastic ball sprayer nozzle

Buse d'injection spherique en plastique

Su verme misketi

Bestell-Nr. Order Nr. Référence Sipariş Nr.	D	Euro
703.08	8	
703.10	10	
703.12	12	
703.14	14	

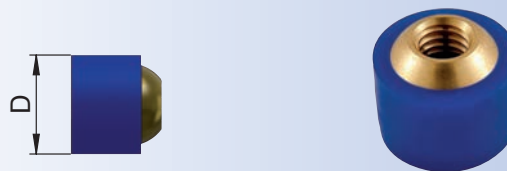

## Verschraubung

### Ball cooling pipe with nut

### Boule frais tube avec vissage

### Somunlu su verme misketi

Bestell-Nr. Order Nr. Référence Sipariş Nr.	M	SØ	L	Euro
--	---	----	---	------

703.M10.15	M10x1	8	15	
703.M10.30	M10x1	8	30	
703.M10.50	M10x1	8	50	

703.M12.15	M12x1	10	15	
703.M12.30	M12x1	10	30	
703.M12.50	M12x1	10	50	

* 704.M10	M10x1	8	-	
* 704.M12	M12x1	10	-	

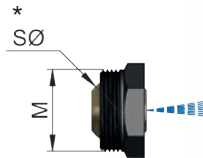
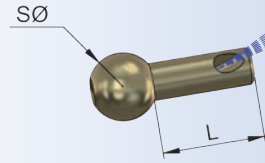
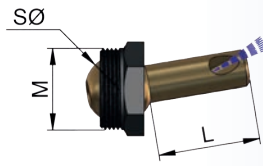

Bestell-Nr. Order Nr. Référence Sipariş Nr.	SØ	L	Euro
--	----	---	------

703.S08.15	8	15	
703.S08.30	8	30	
703.S08.50	8	50	

703.S10.15	10	15	
703.S10.30	10	30	
703.S10.50	10	50	

Bestell-Nr. Order Nr. Référence Sipariş Nr.	M	Euro
--	---	------

703.M10	M10x1	
703.M12	M12x1	

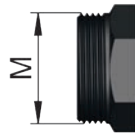

## Kegelwischer

### Taper wiper

### Cônes de nettoyage

### Konik temizleyici

Bestell-Nr. Order Nr. Référence Sipariş Nr.	Abmessung Size Dimension Cinsi	Euro
--	---	------

710.01	MK 1	
710.02	MK 2	
710.03	MK 3	
710.04	MK 4	
710.05	MK 5	

710.30	SK 30	
710.40	SK 40	
710.50	SK 50	

710.32.HSK	HSK 32	
710.40.HSK	HSK 40	
710.50.HSK	HSK 50	
710.63.HSK	HSK 63	
710.80.HSK	HSK 80	
710.100.HSK	HSK 100	



MK



SK



HSK



## Montageblock aus Stahl, schwenkbar

Universal assembly block steel

Bloc de montage universel en fer

Çelik montaj aparatı sağa ve sola 90° dönebilen

Bestell-Nr. Order Nr. Référence Sipariş Nr.	Abmessung Size Dimension Cinsi	L	H	B	Euro
705.30	SK 30	125	121	64	
705.40	SK 40	130	136	64	
705.50	SK 50	170	170	72	
709.16	VDI 16	100	97	48	
709.20	VDI20	100	97	48	
709.25	VDI 25	100	97	48	
709.30	VDI 30	130	121	64	
709.40	VDI 40	130	136	64	
709.50	VDI 50	170	170	72	
708.32	HSK32-A	100	97	48	
708.40	HSK40-A	100	97	48	
708.50	HSK50-A	125	121	64	
708.63	HSK63-A	130	136	64	
708.80	HSK80-A	170	170	72	
708.100	HSK100-A	170	170	72	

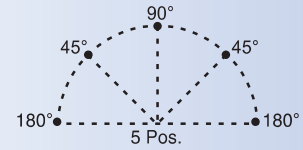
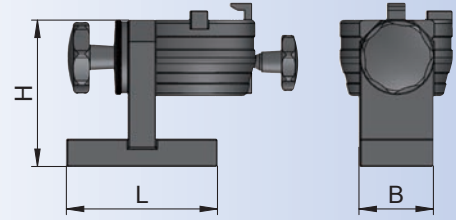

## Montageblock aus Stahl

Assembly block steel

Bloc de montage

Çelik montaj aparatı

Bestell-Nr. Order Nr. Référence Sipariş Nr.	Abmessung Size Dimension Cinsi	L	H	B	Euro
707.30	ISO 30	111	153	88	
707.40	ISO 40	114	157	100	
707.50	ISO 50	160	200	144	

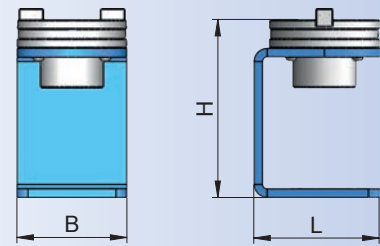



## Schnellmontageblock mit Rollenlager aus Stahl, Universal

### Fast-mounting assembly block steel, universal

### Bloc de montage rapide de l'acier, universel

### Pratik universal çelik montaj aparatı

Bestell-Nr. Order Nr. Référence Sipariş Nr.	Abmessung Size Dimension Cinsi	D	Euro
705.40/63	SK 40-BT 40-HSK 63-EPS 63	63	

\* Zur Aufnahme von HSK 63 - EPS 63 - SK 40 - BT 40

For clamping of HSK 63 - EPS 63 - SK 40 - BT 40

Pour le serrage de HSK 63 - EPS 63 - SK 40 - BT 40

HSK 63 - EPS 63 - SK 40 - BT 40 tipi başlıklar için

\* 45° und 90° - 5 verschiedene Positionen verwendbar

45° and 90° - can be used in 5 different positions

45° et 90° - 5 différentes positions applicables

45° ve 90° - 5 ayrı pozisyonda kullanılabilir

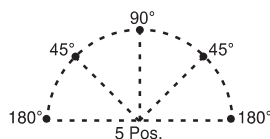

\* Gesichert gegen Herausfallen durch Arretierung

Secured against falling down with adjustment lock

Assuré contre tomber par un blocage

Takımlar aparat içinde pozisyonlarda kilitlenerek düşmesi engellenir

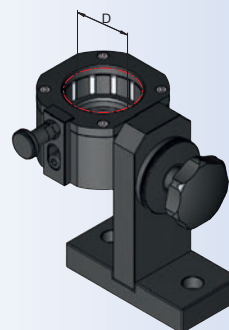

\* Klemmung über Rollenlager am Bund ohne Kontakt des Kegels

Clamping with sliding-contact bearings at the flange,  
no contact with cone

Serrage sur le roulement à galets à l'embase sans contact du cône

Koniğe temas etmeden dış çaptan bilyalar sayesinde sıkıştırılabilir

## Schnellmontageblock aus Stahl mit Rollenlager

### Quick-change mounting assembly block steel, with roller bearings

### Bloc de montage rapide de l'acier avec roulements à roulex

### Bilyalı çelik montaj aparatı

Bestell-Nr. Order Nr. Référence Sipariş Nr.	Abmessung Size Dimension Cinsi	D	L	H	B	Euro
706.30	BT 30	46	111	165	88	
706.32	HSK 32 - EPS 32	32	85	120	74	
706.40	HSK 40 - EPS 40	40	85	120	74	
706.50	SK 30 - HSK 50 - EPS 50	50	111	165	88	
706.50.1	SK 50	97,5	160	209	144	
706.63	SK 40 - BT 40- HSK 63 - EPS 63	63	114	170	100	
706.80	HSK 80 - EPS 80	80	130	175	122	
706.100	HSK 100 - BT 50	100	160	209	144	

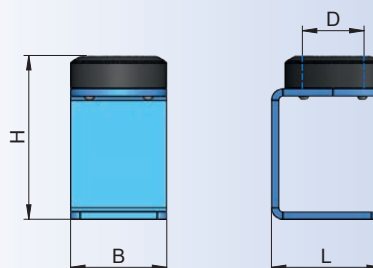



## Montageblock aus Aluminium

Tightening fixtures Aluminium

Bloc de montage en aluminium

Montaj aparatı alüminyum

Bestell-Nr. Order Nr. Référence Sipariş Nr.	Abmessung Size Dimension Cinsi	L	H	B	Euro
700.30	SK 30	127	75	47	
700.40	SK 40	160	105	62	
700.50	SK 50	180	155	99	

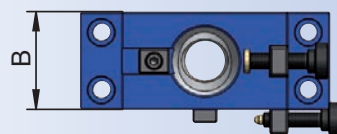
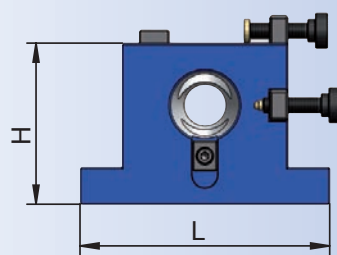

## NC - Bohrfutter mit MK Schaft für Rechts - und Linkslauf MK

NC - Drill chucks with MK shaft for left and right rotation MK

Mandrin de perçage CNC avec cône morse pour rotation gauche-droite MK

MK shaftlı NC tipi mandren malafası komple sağ ve sol dönüflü MK



Bestell-Nr. Order Nr. Référence Sipariş Nr.	MK	Spannbereich Capacity Capacité Kapasite	A	D	Euro
082.15.08.75	2	0,5 - 8	75	36	
082.15.13.105	2	1,0 - 13	105	50	
082.15.16.110	2	3,0 - 16	110	57	
083.15.08.75	3	0,5 - 8	75	36	
083.15.13.100	3	1,0 - 13	100	50	
083.15.16.105	3	3,0 - 16	105	57	
084.15.13.104	4	1,0 - 13	104	50	
084.15.16.109	4	3,0 - 16	109	57	

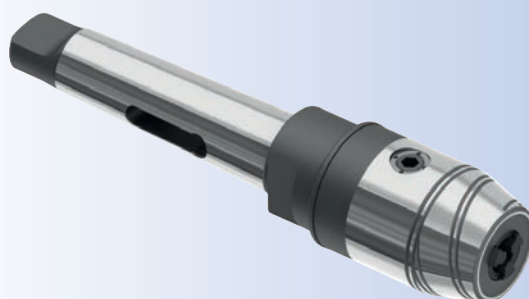
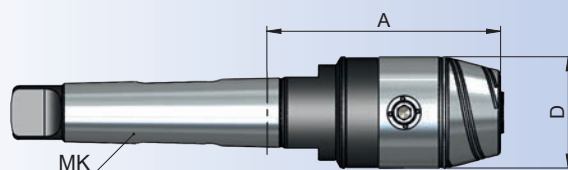

## Zubehör / Accessories / Accessoires / Yedekler



Ersatzteile  
Spare Parts  
Pièce de rechange  
Yedek parçalar



Spannschlüssel  
Wrench  
Clé de serrage  
Sıkma anahtar







## Tischwerkzeuggestell

Verschweißte, lackierte Stahlblechkonstruktion  
Werkzeugaufnahmen mit Kunststoffeinsätzen

Benchtop tool shelf, made of welded sheet steel,  
with plastic tool holders

Support de table pour outils  
Fabrication soudée, vernie en tôle d'acier  
Insert d'outil en plastique

Masa üstü takım sehpası, takım tutucu yeri plastik

Bestell-Nr. Order Nr. Référence Sipariş Nr.	Abmessung Size Dimension Cinsi	Anzahl Einsätze Inserts Takım Adedi	B	T	H	Euro	
793.30	SK 30	21	700	400	500		
793.40	SK 40	18	700	400	500		
793.50	SK 50	15	700	400	500		
794.16	VDI 16	21	700	400	500		
794.20	VDI 20	21	700	400	500		
794.25	VDI 25	21	700	400	500		
794.30	VDI 30	21	700	400	500		
794.40	VDI 40	18	700	400	500		
794.50	VDI 50	15	700	400	500		
795.32	HSK 32	21	700	400	500		
795.40	HSK 40	21	700	400	500		
795.50	HSK 50	21	700	400	500		
795.63	HSK 63	18	700	400	500		
795.80	HSK 80	15	700	400	500		
795.100	HSK 100	15	700	400	500		
<b>new</b>	796.63	EPS 63	18	700	400	500	

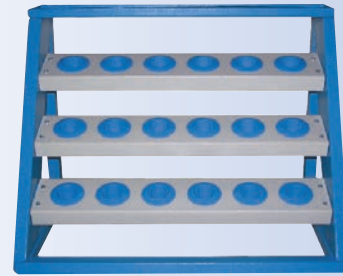
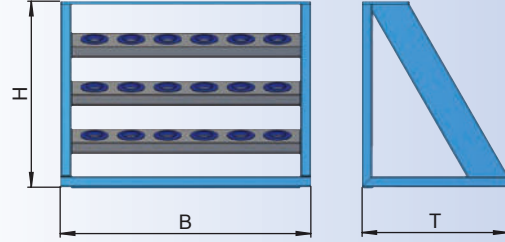



## Transport - und Werkzeugwagen

Verschweißte, lackierte Stahlblechkonstruktion  
2 Bockrollen und 2 Lenkrollen mit feststeter  
Werkzeugaufnahmen mit Kunststoffeinsätzen

Benchtop tool shelf, made of welded sheet steel,  
2 Steering castors and 2 fixed castors with  
locking device, plastic tool holders

Support de table pour outils  
Fabrication soudée, vernie en tôle d'acier  
2pieds fixes, 2 pieds de guidage avec linguet  
Insert d'outil en plastique

Taşınabilir çift taraflı takım arabası, dönerli, kilitlenen  
ve sabit tekerlekli, takım tutucu yeri plastik

Bestell-Nr. Order Nr. Référence Sipariş Nr.	Abmessung Size Dimension Cinsi	Anzahl Einsätze Inserts Takım Adedi	B	T	H	Euro	
790.30	SK 30	70	700	600	1260		
790.40	SK 40	60	700	600	1260		
790.50	SK 50	50	700	600	1260		
791.16	VDI 16	70	700	600	1260		
791.20	VDI 20	70	700	600	1260		
791.25	VDI 25	70	700	600	1260		
791.30	VDI 30	70	700	600	1260		
791.40	VDI 40	60	700	600	1260		
791.50	VDI 50	50	700	600	1260		
792.32	HSK32	70	700	600	1260		
792.40	HSK40	70	700	600	1260		
792.50	HSK50	70	700	600	1260		
792.63	HSK63	60	700	600	1260		
792.80	HSK80	50	700	600	1260		
792.100	HSK100	50	700	600	1260		
<b>new</b>	793.63	EPS 63	60	700	600	1260	

